



Multi 3320

METER FOR 2 SENSORS (PH/ORP/D.O./COND)



a xylem brand



For the most recent version of the manual, please visit www.WTW.com.

Copyright

© Weilheim 2014, WTW GmbH
Reproduction in whole - or even in part - is prohibited without the
express written permission of WTW GmbH, Weilheim.
Printed in Germany..

Multi 3320 - Contents

1	Overview	7
1.1	Multi 3320 meter	7
1.2	Sensors	7
2	Safety instructions	8
2.1	Safety information	8
2.1.1	Safety information in the operating manual	8
2.1.2	Safety signs on the meter	8
2.1.3	Further documents providing safety information	8
2.2	Safe operation	9
2.2.1	Authorized use	9
2.2.2	Requirements for safe operation	9
2.2.3	Unauthorized use	9
3	Commissioning	10
3.1	Scope of delivery	10
3.2	Power supply	10
3.3	Initial commissioning	10
3.3.1	Inserting the batteries	11
4	Operation	12
4.1	General operating principles	12
4.1.1	Keypad	12
4.1.2	Display	13
4.1.3	Status information (meter)	13
4.1.4	Socket field	14
4.2	Switching on the meter	14
4.3	Switching off	15
4.4	Navigation	15
4.4.1	Operating modes	15
4.4.2	Measured value display	16
4.4.3	Menus and dialogs	16
4.4.4	Elements in menus and dialogs	16
4.4.5	Example 1 on navigation: Setting the language	17
4.4.6	Example 2 on navigation: Setting the date and time	19
4.5	Channel display	21
4.5.1	Display of several sensors in the measuring mode	21
5	pH value	22

5.1	Measuring	22
5.1.1	Measuring the pH value	22
5.1.2	Measuring the temperature.	24
5.2	Calibration	25
5.2.1	Why calibrate?	25
5.2.2	When do you have to calibrate?	25
5.2.3	Automatic calibration (AutoCal)	25
5.2.4	Manual calibration (ConCal)	28
5.2.5	Calibration points	31
5.2.6	Calibration data.	32
5.2.7	Continuous measurement control (CMC function)	34
6	ORP voltage.	36
6.1	Measuring	36
6.1.1	Measuring the ORP	36
6.1.2	Measuring the temperature.	38
6.2	ORP calibration	38
7	Ion concentration	39
7.1	Measuring	39
7.1.1	Measuring the ion concentration	39
7.1.2	Measuring the temperature.	41
7.2	Calibration	42
7.2.1	Why calibrate?	42
7.2.2	When to calibrate?	42
7.2.3	Calibration (ISE Cal)	42
7.2.4	Calibration standards	45
7.2.5	Calibration data.	45
8	Dissolved oxygen	47
8.1	Measuring	47
8.1.1	Measuring D.O.	47
8.1.2	Measuring the temperature.	49
8.2	Calibration	50
8.2.1	Why calibrate?	50
8.2.2	When to calibrate?	50
8.2.3	Calibration procedures	50
8.2.4	Calibration in water vapor-saturated air (air calibration vessel)	50
8.2.5	Calibrating with a Comparison meas. (OxiComp)	51
8.2.6	Calibration data.	53
9	Conductivity	55
9.1	Measuring	55

9.1.1	Measuring the conductivity.	55
9.1.2	Measuring the temperature	57
9.2	Calibration	57
9.2.1	Why calibrate?	57
9.2.2	When to calibrate?	57
9.2.3	Determining the cell constant (calibration in control standard)	57
9.2.4	Calibration data	58
10	Settings	61
10.1	Measurement settings	61
10.1.1	Settings for pH measurements.	61
10.1.2	Buffer sets for calibration	62
10.1.3	Calibration interval	64
10.1.4	Settings for ORP measurements	65
10.1.5	Settings for ISE measurements	66
10.1.6	Settings for D.O. sensors	68
10.1.7	Calibration interval	69
10.1.8	Settings for conductivity measuring cells	70
10.1.9	Calibration interval	72
10.1.10	Temperature compensation	72
10.1.11	Setting the TDS factor	73
10.2	Sensor-independent settings	74
10.2.1	<i>System</i>	74
10.2.2	<i>Data storage</i>	75
10.3	Reset.	75
10.3.1	Resetting the measurement settings.	75
10.3.2	Resetting the system settings	77
11	Data storage	78
11.1	Manual storage	78
11.2	Automatic data storage at intervals	79
11.3	Measurement data storage	81
11.3.1	Editing the measured value storage.	81
11.3.2	Erasing the measurement data storage.	83
11.3.3	Measurement dataset	83
11.3.4	Storage locations	83
12	Transmitting data (USB interface).	84
12.1	Options for data transmission	84
12.2	Connecting a PC.	85
12.3	MultiLab Importer	85
13	Maintenance, cleaning, disposal.	86
13.1	Maintenance	86
13.1.1	General maintenance activities	86

- 13.1.2 Replacing the batteries 86
- 13.2 Cleaning 87
- 13.3 Packing 87
- 13.4 Disposal 87
- 14 What to do if... 88**
 - 14.1 pH/ORP 88
 - 14.2 ISE 90
 - 14.3 Dissolved oxygen 91
 - 14.4 Conductivity 92
 - 14.5 General information 93
- 15 Technical data 94**
 - 15.1 Measuring ranges, resolution, accuracy 94
 - 15.1.1 pH/ORP 94
 - 15.1.2 ISE 95
 - 15.1.3 Oxi 95
 - 15.1.4 Cond 97
 - 15.2 General data 99
- 16 Firmware update 100**
- 17 Glossary 101**
- 18 Index 105**

1 Overview

1.1 Multi 3320 meter

The Multi 3320 meter enables you to perform measurements (pH, U, ISE, conductivity, dissolved oxygen (D.O.)) quickly and reliably.

The Multi 3320 provides the maximum degree of operating comfort, reliability and measuring certainty for all applications.

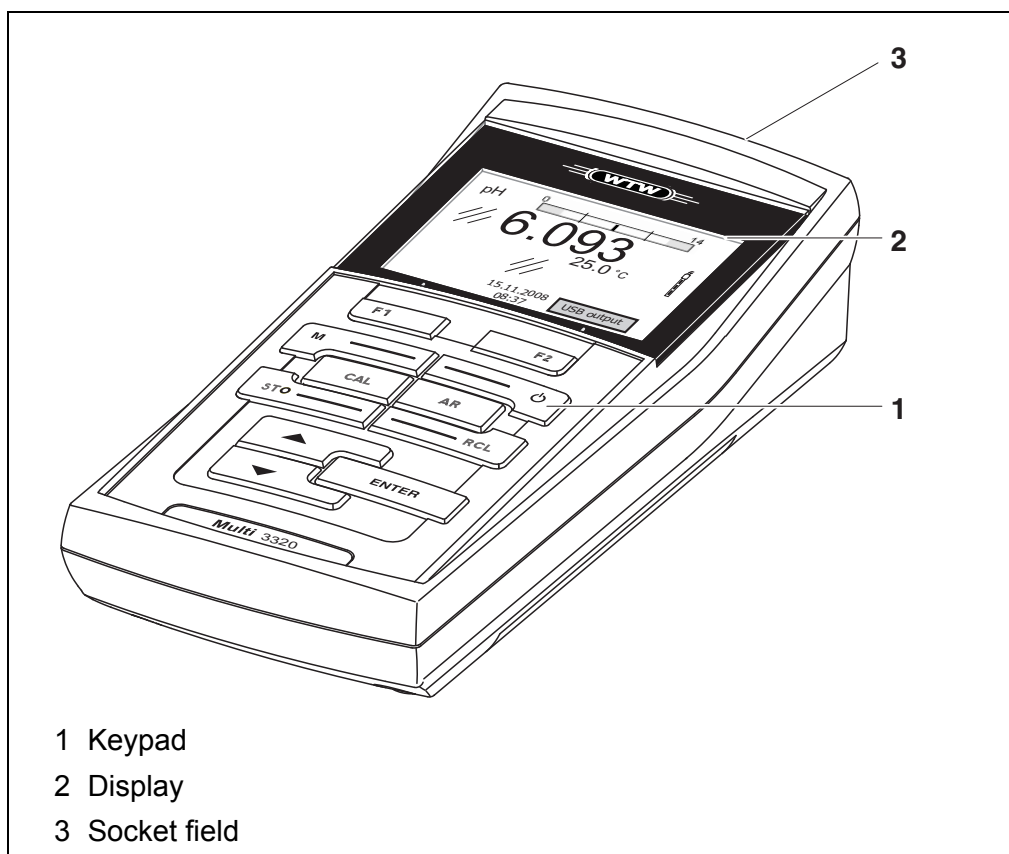

1.2 Sensors

A measuring system ready to measure consists of the Multi 3320 meter and a suitable sensor.

Suitable sensors are pH electrodes, ion selective electrodes (ISE), ORP electrodes, dissolved oxygen (D.O.) sensors and conductivity measuring cells.



Information on available sensors is given on the Internet and in the WTW catalog, "Laboratory and field instrumentation".

2 Safety instructions

2.1 Safety information

2.1.1 Safety information in the operating manual

This operating manual provides important information on the safe operation of the meter. Read this operating manual thoroughly and make yourself familiar with the meter before putting it into operation or working with it. The operating manual must be kept in the vicinity of the meter so you can always find the information you need.

Important safety instructions are highlighted in this operating manual. They are indicated by the warning symbol (triangle) in the left column. The signal word (e.g. "CAUTION") indicates the level of danger:

**WARNING**

indicates a possibly dangerous situation that can lead to serious (irreversible) injury or death if the safety instruction is not followed.

**CAUTION**

indicates a possibly dangerous situation that can lead to slight (reversible) injury if the safety instruction is not followed.

NOTE

indicates a possibly dangerous situation where goods might be damaged if the actions mentioned are not taken.

2.1.2 Safety signs on the meter

Note all labels, information signs and safety symbols on the meter and in the battery compartment. A warning symbol (triangle) without text refers to safety information in this operating manual.

2.1.3 Further documents providing safety information

The following documents provide additional information, which you should observe for your safety when working with the measuring system:

- Operating manuals of sensors and other accessories
- Safety datasheets of calibration or maintenance accessories (such as buffer solutions, electrolyte solutions, etc.)

2.2 Safe operation

2.2.1 Authorized use

This meter is authorized exclusively for pH, ISE, ORP, dissolved oxygen and conductivity measurements in a laboratory environment.

Only the operation and running of the meter according to the instructions and technical specifications given in this operating manual is authorized (see section 15 TECHNICAL DATA, page 94).

Any other use is considered unauthorized.

2.2.2 Requirements for safe operation

Note the following points for safe operation:

- The meter may only be operated according to the authorized use specified above.
- The meter may only be supplied with power by the energy sources mentioned in this operating manual.
- The meter may only be operated under the environmental conditions mentioned in this operating manual.
- The meter may only be opened if this is explicitly described in this operating manual (example: Inserting the batteries).

2.2.3 Unauthorized use

The meter must not be put into operation if:

- it is visibly damaged (e.g. after being transported)
- it was stored under adverse conditions for a lengthy period of time (storing conditions, see section 15 TECHNICAL DATA, page 94).

3 Commissioning

3.1 Scope of delivery

- MeterMulti 3320
- 4 batteries 1.5 V Mignon type AA
- Short instructions
- CD-ROM with
 - USB drivers
 - detailed operating manual
 - Software MultiLab Importer

3.2 Power supply

The Multi 3320 is supplied with power in the following ways:

- Battery operation (4 x alkaline manganese batteries, type AA)
- USB operation via a connected USB-B cable

3.3 Initial commissioning

Perform the following activities:

- Insert the supplied batteries
- Switch on the meter (see section 4.2 SWITCHING ON THE METER, page 14)
- Set the date and time (see section 4.4.6 EXAMPLE 2 ON NAVIGATION: SETTING THE DATE AND TIME, page 19)

3.3.1 Inserting the batteries



You can operate the meter either with normal batteries or with rechargeable batteries (Ni-MH). In order to charge the batteries, an external charging device is required.

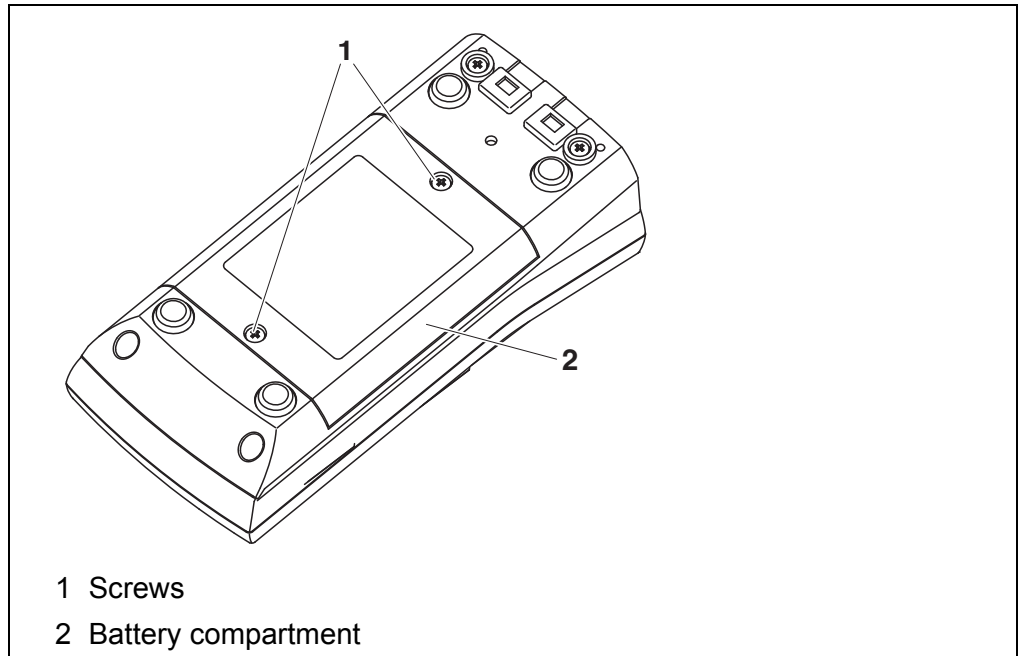

1. Unscrew the two screws (1) on the underside of the meter.
2. Open the battery compartment (2) on the underside of the meter.



CAUTION

Make sure that the poles of the batteries are positioned correctly.

The \pm signs on the batteries must correspond to the \pm signs in the battery compartment.











3. Place four batteries (type Mignon AA) in the battery compartment.
4. Close the battery compartment (2) and tighten the screws (1).
5. Set the date and time
(see section 4.4.6 EXAMPLE 2 ON NAVIGATION: SETTING THE DATE AND TIME, page 19).

4 Operation

4.1 General operating principles

4.1.1 Keypad



In this operating manual, keys are indicated by brackets <.> .
The key symbol (e.g. <ENTER>) generally indicates a short keystroke (under 2 sec) in this operating manual. A long keystroke (approx. 2 sec) is indicated by the underscore behind the key symbol (e.g. <ENTER__>).

	<F1>: <F1__>:	Softkeys providing situation dependent functions, e.g.: <F2>/[USB output]: Outputs data to the USB interface <F2__>/[USB output]: Configures the automatic data output to the USB interface
	<F2>: <F2__>:	
	<On/Off>:	Switches the meter on or off
	<M>:	Selects the measured parameter / Quits the settings
	<CAL>: <CAL__>:	Calls up the calibration procedure Displays the calibration data
	<STO>: <STO__>:	Saves a measured value manually Opens the menu for the automatic save function
	<RCL>: <RCL__>:	Displays the manually stored measured values Displays the automatically stored measured values
 	<▲><▼>: <▲__><▼__>:	Menu control, navigation Increments, decrements values Increments, decrements values continuously
	<ENTER>: <ENTER__>:	Opens the menu for measurement settings / confirms entries Opens the menu for system settings
	<AR>	Freezes the measured value (HOLD function) Switches the AutoRead measurement on or off

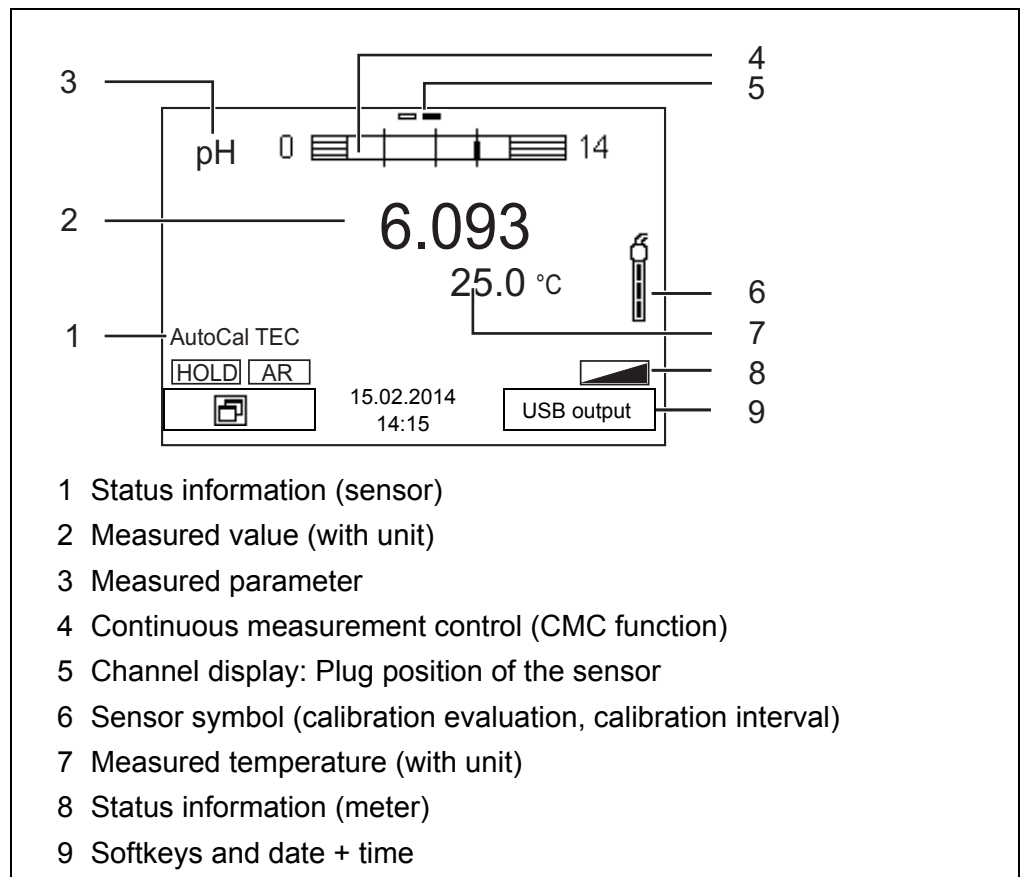
4.1.2 Display



4.1.3 Status information (meter)

AR	Stability control (AutoRead) is active
HOLD	Measured value is frozen (<AR> key)
	Batteries are almost empty
	Data are automatically output to the USB-B interface at intervals

4.1.4 Socket field

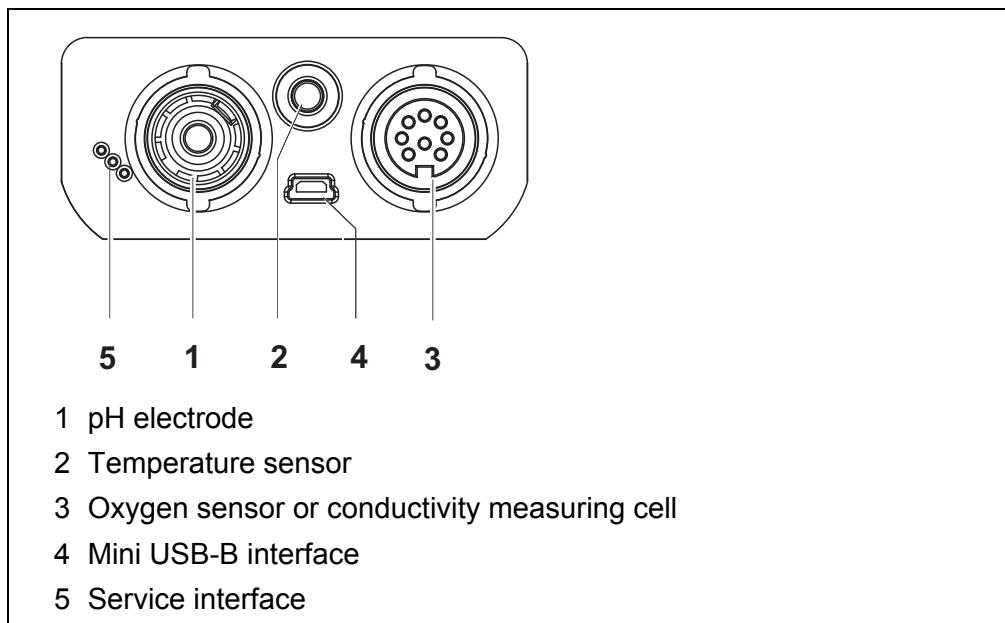

CAUTION

Only connect sensors to the meter that cannot return any voltages or currents that are not allowed (> SELV and > current circuit with current limiting).

Almost all customary sensors fulfill these conditions.

4.2 Switching on the meter

1. Switch the meter on with **<On/Off>**.
The meter performs a self-test.
The display shows the manufacturer's logo while the self-test is being performed.
The measured value display appears.

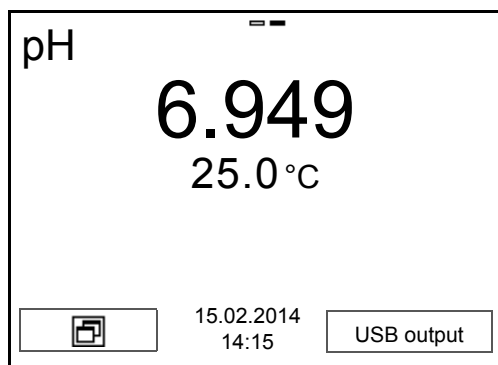

4.3 Switching off

1. Switch the printer off with **<On/Off>**.

Automatic switch-off

The instrument has an automatic switch-off function in order to save the batteries (see section 10.2.1 SYSTEM, page 74). The automatic switchoff function switches off the meter if no key is pressed for an adjustable period.

The automatic switchoff function is not active

- if the communication cable is connected
- if the *Automatic data storage* function is active, or with automatic data transmission

Display illumination

The meter automatically switches off the display illumination if no key is pressed for 30 seconds. The illumination is switched on with the next keystroke again.

You can also generally switch the display illumination on or off (see section 10.2.1 SYSTEM, page 74).

4.4 Navigation

The principles of navigation in menus and dialogs are explained in the following sections.

4.4.1 Operating modes

The instrument has the following operating modes:

Operating mode	Description
Measuring	The measurement data of the connected sensor are shown in the measured value display
Calibration	The course of a calibration with calibration information, functions and settings is displayed
Storage in memory	The meter stores measuring data automatically or manually
Transmitting data	The meter transmits measuring data and calibration records to a USB-B interface automatically or manually.
Setting	The system menu or a sensor menu with submenus, settings and functions is displayed

Only those displays and functions are available in the active operating mode that are currently being required.

4.4.2 Measured value display

In the measured value display, open the setting menus with **<ENTER>**. The current functions of the softkeys are shown on the display.

- Use **<ENTER>** (short pressure) to open the menu for calibration and measurement settings for the displayed measured parameter.
- Use **<ENTER__>** (long keystroke (approx. 2 s) to open the *Storage & config* menu with the sensor-independent settings.

Use the keys of the keypad to carry out further functions such as storage or calibration (see section 4.1.1 KEYPAD, page 12). These functions are not available in other operating situations.

4.4.3 Menus and dialogs

The menus for settings and dialogs in procedures contain further subelements.

- To select a subelement, use the **<▲><▼>** keys. The current selection is displayed with a frame.
- To make further settings, switch to the next higher menu level with **<F1>**[Back].
- Use **<M>** to return to the measured value display.

4.4.4 Elements in menus and dialogs

- Submenus

The name of the submenu is displayed at the upper edge of the frame. Submenus are opened by confirming with **<ENTER>**. Example:

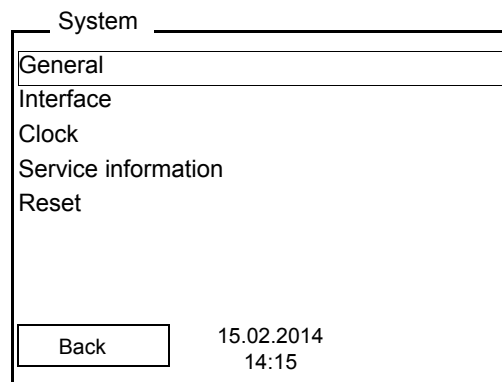

- Settings

Settings are indicated by a colon. The current setting is displayed on the right-hand side. The setting mode is opened with **<ENTER>**. Subsequently, the setting can be changed with **<▲><▼>** and **<ENTER>**. Example:

General	
Language:	Deutsch
Beep:	Off
Illumination:	On
Contrast:	50 %
Switchoff time:	1 h
Temperature unit:	°C
Stability control:	On
<input type="button" value="Back"/> 15.02.2014 14:15	

- **Functions**

Functions are designated by the name of the function. They are immediately carried out by confirming with **<ENTER>**.

Example: Display the *Calibration record* function.

pH	
Calibration record	
Calibration data storage	
Buffer:	TEC
One point calibration:	Yes
Calibration interval:	7 d
Unit for slope:	mV/pH
i 2.00 4.01 7.00 10.01	
<input type="button" value="Back"/> 15.02.2014 14:15	

- **Messages**

Information is marked by the **i** symbol. It cannot be selected. Example:

pH	
Calibration record	
Calibration data storage	
Buffer:	<input type="text" value="TEC"/>
One point calibration:	Yes
Calibration interval:	7 d
Unit for slope:	mV/pH
i 2.00 4.01 7.00 10.01	
<input type="button" value="Back"/> 15.02.2014 14:15	

4.4.5 Example 1 on navigation: Setting the language

1. Press the **<On/Off>** key.
The measured value display appears.
The instrument is in the measuring mode.

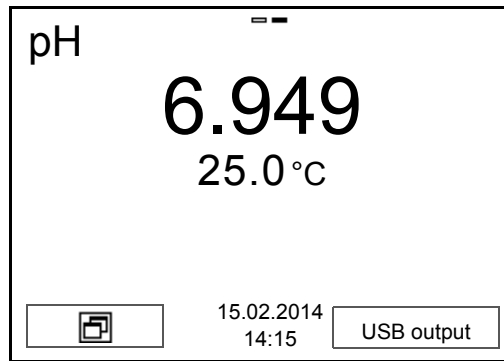

- Using **<ENTER>**, open the *Storage & config* menu. The instrument is in the setting mode.

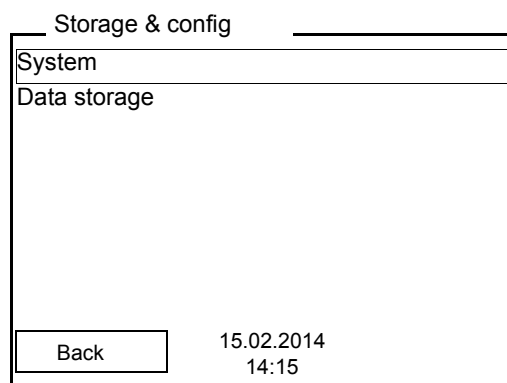

- Select the *System* submenu with **<▲><▼>**. The current selection is displayed with a frame.
- Open the *System* submenu with **<ENTER>**.

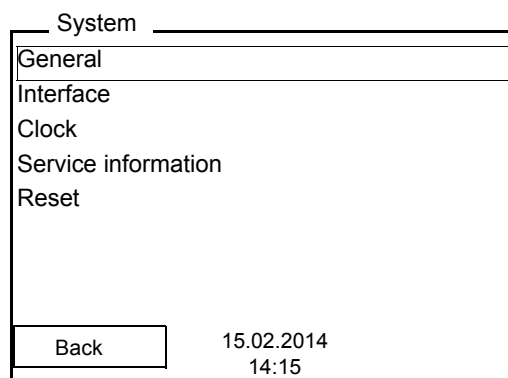

- Select the *General* submenu with **<▲><▼>**. The current selection is displayed with a frame.
- Open the *General* submenu with **<ENTER>**.

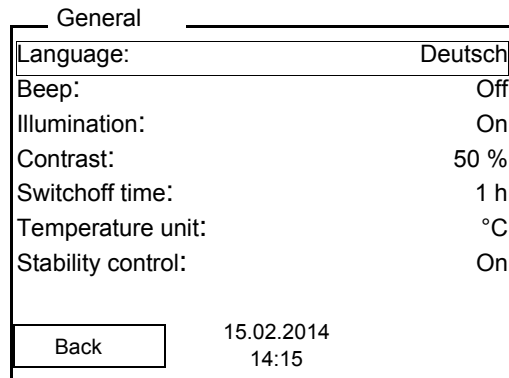

7. Open the setting mode for the *Language* with **<ENTER>**.

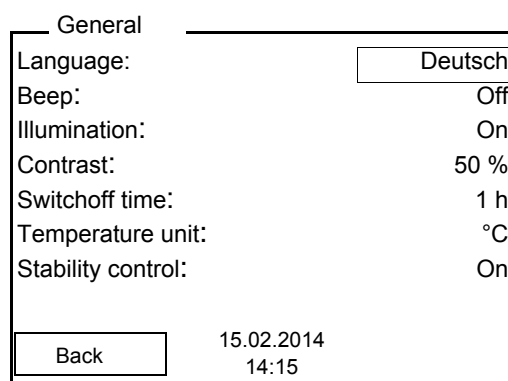

8. Select the required language with **<▲><▼>**.
9. Confirm the setting with **<ENTER>**.
The meter switches to the measuring mode.
The selected language is active.

4.4.6 Example 2 on navigation: Setting the date and time

The meter has a clock with a date function. The date and time are shown in the measured value display.

When storing measured values and calibrating, the current date and time are automatically stored as well.

The correct setting of the date and time and date format is important for the following functions and displays:

- Current date and time
- Calibration date
- Identification of stored measured values.

Therefore, check the time at regular intervals.



After a fall of the supply voltage (empty batteries), the date and time are reset to 01.01.2011 00, 00:00 hours.

The date format can be switched from the display of day, month, year (*dd.mm.yyyy*) to the display of month, day, year (*mm/dd/yyyy* or *mm.dd.yyyy*).

1. In the measured value display:
Using **<ENTER__>**, open the *Storage & config* menu.
The instrument is in the setting mode.
2. Select and confirm the *System / Clock* menu with **<▲><▼>** and **<ENTER>**.
The setting menu for the date and time opens up.
3. Select and confirm the *Time* menu with **<▲><▼>** and **<ENTER>**.
The hours are highlighted.

Clock	
Date format:	dd.mm.yyyy
Date:	15.02.2014
Time:	14:15:25
<div style="display: flex; justify-content: space-between; align-items: center;"> <div style="border: 1px solid black; padding: 2px 5px;">Back</div> <div style="text-align: center;"> 15.02.2014 14:15 </div> </div>	

4. Change and confirm the setting with **<▲><▼>** and **<ENTER>**.
The minutes are highlighted.
5. Change and confirm the setting with **<▲><▼>** and **<ENTER>**.
The seconds are highlighted.
6. Change and confirm the setting with **<▲><▼>** and **<ENTER>**.
The time is set.
7. If necessary, set the *Date* and *Date format*. The setting is made similarly to that of the time.
8. To make further settings, switch to the next higher menu level with **[Back]<F1>**.
or
Switch to the measured value display with **<M>**.
The instrument is in the measuring mode.

4.5 Channel display

The Multi 3320 manages the connected sensors and displays which sensor is plugged to which connection.

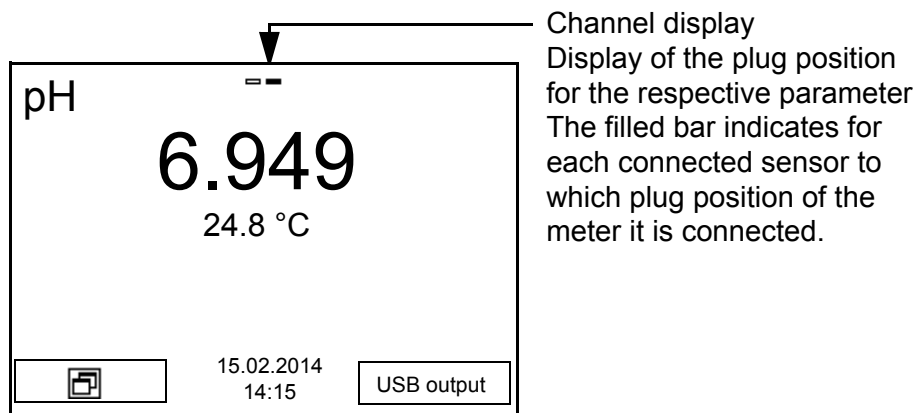

4.5.1 Display of several sensors in the measuring mode

The measured values of the connected sensors can be displayed in the following ways:

- Clear display of all connected sensors
- Detailed display of one sensor
(e.g. incl. CMC feature with pH sensors)

With the softkey you can very easily switch between the two display types. The suitable softkey is displayed depending on the operating situation.

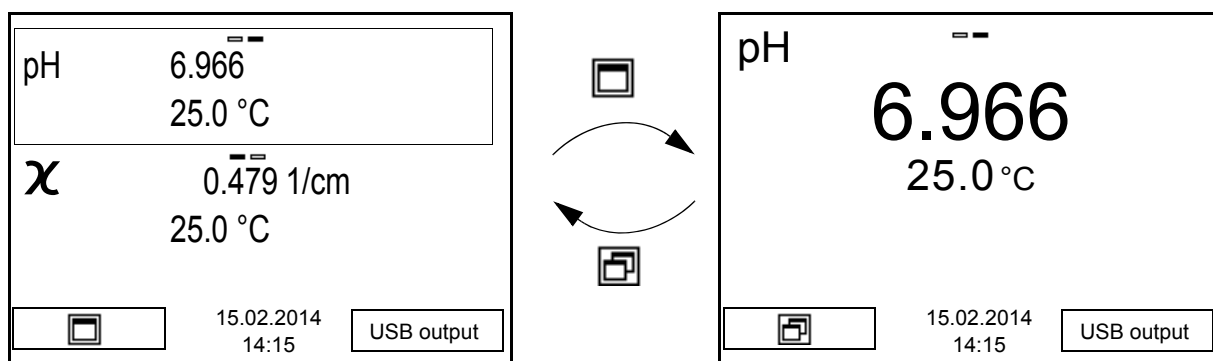

5 pH value

5.1 Measuring

5.1.1 Measuring the pH value

NOTE

When connecting an earthed PC/printer, measurements cannot be performed in earthed media as the values would be incorrect. The USB interface is not galvanically isolated.



To ensure the high measurement accuracy of the measuring system, always measure with a calibrated electrode (see section 5.2 CALIBRATION, page 25).

1. Connect the pH electrode to the meter.
2. If necessary, select the measured parameter with <M>.
3. When measuring without temperature sensor:
 - Temper the test sample, or measure the current temperature.
 - Enter the temperature value in the menu.
4. Immerse the pH electrode in the test sample. The measured value is checked for stability (automatic stability control). The display of the measured parameter flashes.
5. Wait for a stable measured value. The display of the measured parameter no longer flashes.

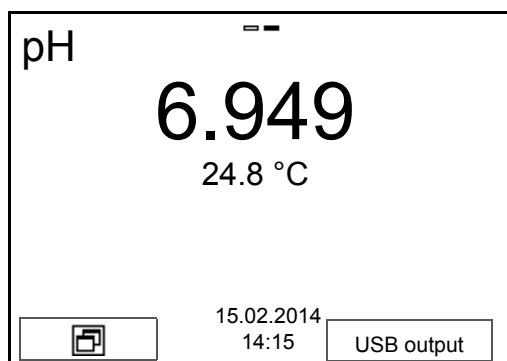

Stability control (AutoRead) & HOLD function

The stability control function (*AutoRead*) continually checks the stability of the measurement signal. The stability has a considerable impact on the reproducibility of measured values.

The measured parameter flashes on the display

- as soon as the measured value is outside the stability range
- when the automatic *Stability control* is switched off.

You can activate or switch off the automatic *Stability control* function (see section 10.2.1 SYSTEM, page 74).

1. Freeze the measured value with **<AR>**.
The [HOLD] status indicator is displayed.
The HOLD function is active.



You can terminate the *Stability control* function and the HOLD function with **<AR>** or **<M>** at any time.

2. Using **<ENTER>**, activate the *Stability control* function manually.
The [AR] status indicator appears while the measured value is assessed as not stable. A progress bar is displayed and the display of the measured parameter flashes.
The [HOLD][AR] status indicator appears as soon as a stable measured value is recognized. The progress bar disappears and the display of the measured parameter stops flashing.
The current measurement data is output to the interface. Measurement data meeting the stability control criterion is marked by AR.



You can prematurely terminate the *Stability control* function manually with **<ENTER>** at any time. If the *Stability control* function is prematurely terminated, the current measurement data are output to the interface without the AutoRead info.

3. Using **<ENTER>**, start a further measurement with stability control.
or
Release the frozen measured value again with **<AR>** or **<M>**.
The [AR] status display disappears. The display switches back to the previous indication.

Criteria for a stable measured value

The *Stability control* function checks whether the measured values are stable within the monitored time interval.

Measured variable	Time interval	Stability in the time interval
pH value	15 seconds	Δ : better than 0.01 pH
Temperature	15 seconds	Δ : better than 0.5 °C

The minimum duration until a measured value is assessed as stable is the monitored time interval. The actual duration is mostly longer.

5.1.2 Measuring the temperature

For reproducible pH measurements, it is essential to measure the temperature of the test sample.

You have the following options to measure the temperature:

- Automatic measurement of the temperature with the temperature sensor (NTC 30 or Pt 1000) integrated in the sensor.
- Measurement by an external temperature sensor.
- Manual determination and input of the temperature.

The measuring instrument recognizes whether a suitable sensor is connected and automatically switches on the temperature measurement.

The display of the temperature indicates the active temperature measuring mode:

Temperature sensor	Resolution of the temp. display	Temp. measurement
yes	0.1 °C	Automatic with temperature sensor
-	1 °C	Manual

If you wish to measure (or calibrate) without temperature sensor, proceed as follows:

1. Measure the current temperature of the test sample.
2. In the **<ENTER>/pH/Man. temperature** menu, set the temperature value with **<▲><▼>**.

5.2 Calibration

5.2.1 Why calibrate?

pH electrodes age. This changes the zero point (asymmetry) and slope of the pH electrode. As a result, an inexact measured value is displayed. Calibration determines and stores the current values of the zero point and slope of the electrode.

Thus, you should calibrate at regular intervals.

5.2.2 When do you have to calibrate?

- After connecting a sensor
- Routinely within the framework of the company quality assurance
- When the calibration interval has expired

5.2.3 Automatic calibration (AutoCal)

Make sure that in the sensor menu, *Buffer* menu, the buffer set is correctly selected (see 10.1.1 SETTINGS FOR PH MEASUREMENTS, PAGE 61).

Use any one to five buffer solutions of the selected buffer set in ascending or descending order.

Below, calibration with Technical buffers (*TEC*) is described. When other buffer sets are used, other nominal buffer values are displayed. Apart from that, the procedure is identical.



If single-point calibration was set in the menu, the calibration procedure is automatically finished with the measurement of buffer solution 1 and the calibration record is displayed.

1. Connect the pH electrode to the meter.
2. When measuring without temperature sensor:
 - Temper the buffer solution, or measure the current temperature.
 - Enter the temperature value in the menu.
3. In the measured value display, select the measured parameter pH or mV with **<M>**.
4. Start the calibration with **<CAL>**.
The calibration display for the first buffer appears (voltage display).

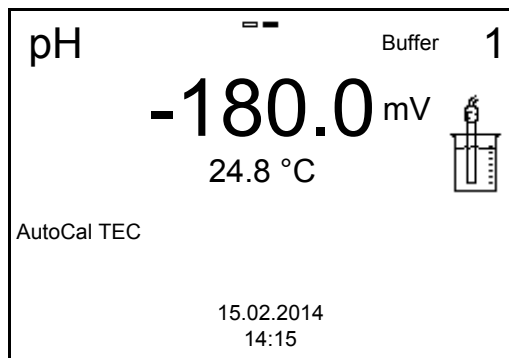

5. Thoroughly rinse the electrode with deionized water.
6. Immerse the electrode in the first buffer solution.
7. When measuring without temperature sensor:
 - Temper the buffer solution, or measure the current temperature.
 - Enter the temperature value in the menu.
8. Start the measurement with **<ENTER>**.
 The measured value is checked for stability (stability control). The [AR] status indicator is displayed. A progress bar is displayed and the display of the measured parameter flashes.

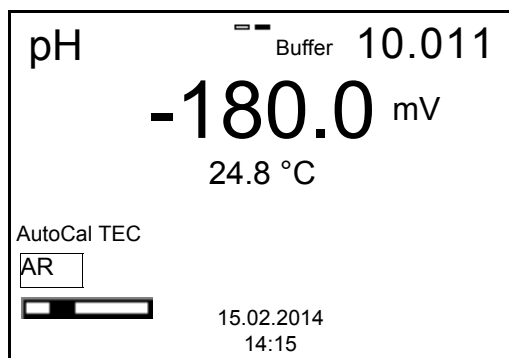

9. Wait for the end of the measurement with stability control or accept the calibration value with **<ENTER>**.
 The calibration display for the next buffer appears (voltage display).
10. If necessary, finish the calibration procedure as a single-point calibration with **<M>**.
 The calibration record is displayed.



For **single-point calibration**, the instrument uses the Nernst slope (-59.2 mV/pH at 25 °C) and determines the zero point of the electrode.

Continuing with two-point calibration

11. Thoroughly rinse the electrode with deionized water.
12. Immerse the electrode in the second buffer solution.

13. When measuring without temperature sensor:
 - Temper the buffer solution, or measure the current temperature.
 - Enter the temperature value in the menu.
14. Start the measurement with **<ENTER>**.
The measured value is checked for stability (stability control). The [AR] status indicator is displayed. A progress bar is displayed and the display of the measured parameter flashes.

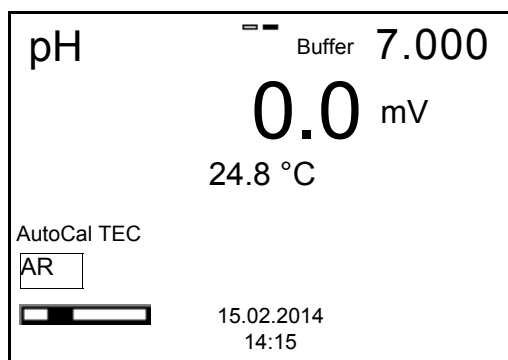

15. Wait for the measurement with stability control to be completed or terminate the stability control and take over the calibration value with **<ENTER>**.
The calibration display for the next buffer appears (voltage display).
16. If necessary, finish the calibration procedure as a two-point calibration with **<M>**.
The calibration record is displayed.

Continuing with three- to five-point calibration

17. Thoroughly rinse the electrode with deionized water.
18. Immerse the electrode in the next buffer solution.
19. When measuring without temperature sensor:
 - Temper the buffer solution, or measure the current temperature.
 - Enter the temperature value in the menu.
20. Start the measurement with **<ENTER>**.
The measured value is checked for stability (stability control). The [AR] status indicator is displayed. A progress bar is displayed and the display of the measured parameter flashes.

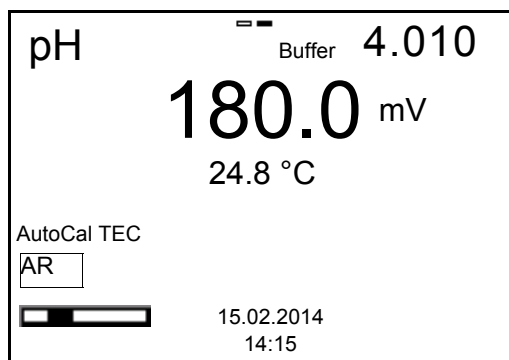

21. Wait for the measurement with stability control to be completed or terminate the stability control and take over the calibration value with **<ENTER>**.
The calibration display for the next buffer appears (voltage display).
22. If necessary, use **<M>** to finish calibration or
Continue calibrating using the next buffer with **<ENTER>**.



Calibration is automatically completed after the last buffer of a buffer set has been measured. Then the calibration record is displayed.

The calibration line is determined by linear regression.

5.2.4 Manual calibration (ConCal)

Make sure that in the sensor menu, *Buffer* menu, the *ConCal* buffer set is selected (see section 10.1.1 SETTINGS FOR PH MEASUREMENTS, page 61).

Use any one to five buffer solutions in ascending or descending order.



If single-point calibration was set in the menu, the calibration procedure is automatically finished with the measurement of buffer solution 1 and the calibration record is displayed.

1. Connect the pH electrode to the meter.
The pH measuring window is displayed.
2. When measuring without temperature sensor:
 - Temper the buffer solution, or measure the current temperature.
 - Enter the temperature value in the menu.
3. In the measured value display, select the measured parameter pH or mV with **<M>**.
4. Start the calibration with **<CAL>**.
The calibration display appears (voltage display).

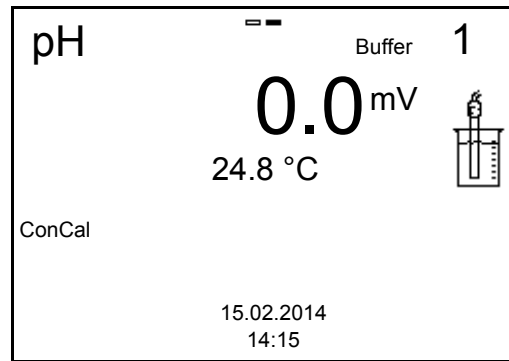

5. Thoroughly rinse the electrode with deionized water.
6. Immerse the electrode in the first buffer solution.
7. When measuring without temperature sensor:
 - Temper the buffer solution, or measure the current temperature.
 - Enter the temperature value in the menu.
8. Start the measurement with **<ENTER>**.
 The measured value is checked for stability (stability control). The [AR] status indicator is displayed. A progress bar is displayed and the display of the measured parameter flashes.

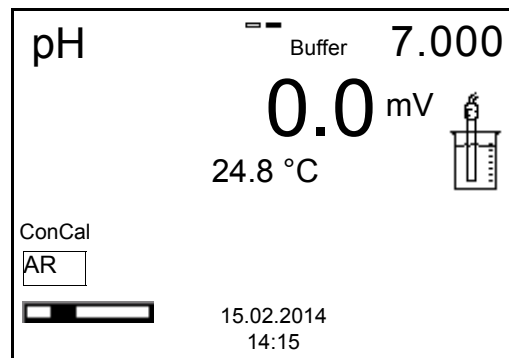

9. Wait for the end of the measurement with stability control or accept the calibration value with **<ENTER>**.
 The calibration display for the setting of the nominal buffer value appears.

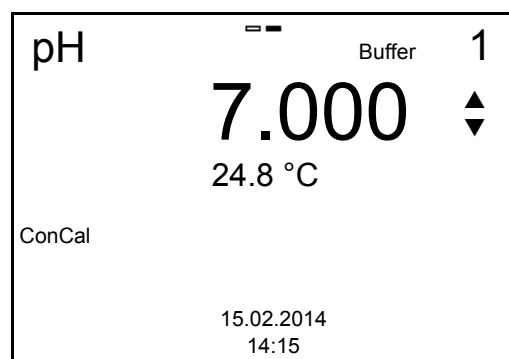

10. Set the nominal buffer value for the measured temperature with **<▲><▼>**.

11. Accept the set calibration value with **<ENTER>**.
The calibration display for the next buffer appears (voltage display).
12. If necessary, finish the calibration procedure as a single-point calibration with **<M>**.
The calibration record is displayed.



For **single-point calibration**, the instrument uses the Nernst slope (-59.2 mV/pH at 25 °C) and determines the zero point of the electrode.

Continuing with two-point calibration

13. Thoroughly rinse the electrode with deionized water.
14. Immerse the electrode in the second buffer solution.
15. When measuring without temperature sensor:
 - Temper the buffer solution, or measure the current temperature.
 - Enter the temperature value in the menu.
16. Start the measurement with **<ENTER>**.
The measured value is checked for stability (stability control). The [AR] status indicator is displayed. A progress bar is displayed and the display of the measured parameter flashes.
17. Wait for the measurement with stability control to be completed or terminate the stability control and take over the calibration value with **<ENTER>**.
The calibration display for the setting of the nominal buffer value appears.

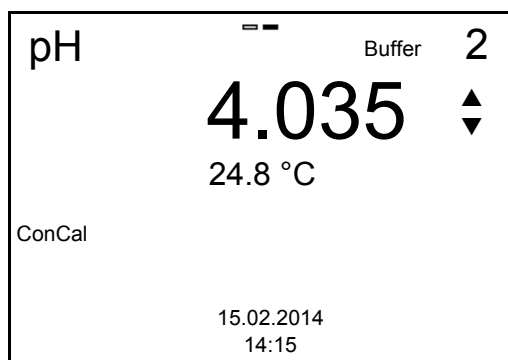

18. Set the nominal buffer value for the measured temperature with **<▲><▼>**.
19. Accept the set calibration value with **<ENTER>**.
The calibration display for the next buffer appears (voltage display).
20. Finish the calibration procedure as a two-point calibration with **<M>**.
The calibration record is displayed.

Continuing with three- to five-point calibration

21. Thoroughly rinse the electrode with deionized water.
22. Immerse the electrode in the next buffer solution.
23. When measuring without temperature sensor:
 - Temper the buffer solution, or measure the current temperature.
 - Enter the temperature value in the menu.
24. Start the measurement with **<ENTER>**.
The measured value is checked for stability (stability control). The [AR] status indicator is displayed. A progress bar is displayed and the display of the measured parameter flashes.
25. Wait for the measurement with stability control to be completed or terminate the stability control and take over the calibration value with **<ENTER>**.
The calibration display for the setting of the nominal buffer value appears.

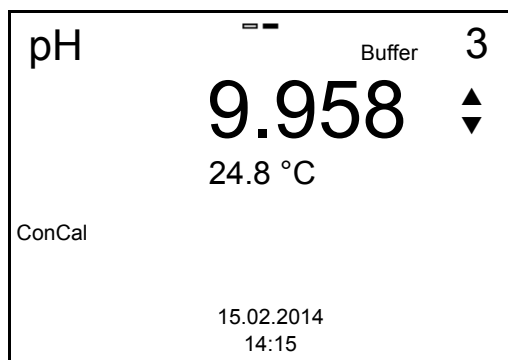

26. Set the nominal buffer value for the measured temperature with **<▲><▼>**.
27. Accept the set calibration value with **<ENTER>**.
The calibration display for the next buffer appears (voltage display).
28. Use **<M>** to finish calibration or
Continue calibrating using the next buffer with **<ENTER>**.



After the fifth buffer has been measured the calibration is automatically finished. Then the calibration record is displayed.

The calibration line is determined by linear regression.

5.2.5 Calibration points

Calibration can be performed using one to five buffer solutions in any order (single-point to five-point calibration). The meter determines the following values and calculates the calibration line as follows:

	Determined values	Displayed calibration data
1-point	Asy	<ul style="list-style-type: none"> ● Zero point = Asy ● Slope = Nernst slope (-59.2 mV/pH at 25 °C)
2-point	Asy Slp.	<ul style="list-style-type: none"> ● Zero point = Asy ● Slope = Slp.
3-point to 5-point	Asy Slp.	<ul style="list-style-type: none"> ● Zero point = Asy ● Slope = Slp. <p>The calibration line is calculated by linear regression.</p>



You can display the slope in the units, mV/pH or % (see section 10.1.1 SETTINGS FOR PH MEASUREMENTS, page 61).

5.2.6 Calibration data



The calibration record is automatically transmitted to the interface after calibrating.

Displaying the calibration data

The calibration record of the last calibration is to be found under the menu item, **<ENTER>** / *Calibration* / *Calibration record*. To open it, press the **<CAL__>** key in the measured value display.

Subsequently, you can transmit the displayed calibration data to the interface, e.g. to a PC, with the **<F2>**[USB output] key.





Displaying the calibration data storage

The calibration records of the last calibrations (up to 10) are given in the menu, **<ENTER>**/ *Calibration* / *Calibration data storage*.

Menu item	Setting/function	Description
<i>Calibration / Calibration data storage / Display</i>	-	Displays the calibration record. Further options: <ul style="list-style-type: none"> ● Scroll through the calibration records with <▲><▼>. ● Output the displayed calibration record to the interface with <F2>/[USB output]. ● Quit the display with <F1>/[Back] or <ENTER>. ● Switch directly to the measured value display with <M>.
<i>Calibration / Calibration data storage / Output to USB</i>	-	Outputs the calibration records to the interface.

Calibration evaluation

After calibrating, the meter automatically evaluates the calibration. The zero point and slope are evaluated separately. The worse evaluation of both is taken into account. The evaluation appears on the display and in the calibration record.

Display	Calibration record	Zero point [mV]	Slope [mV/pH]
	+++	-15 ... +15	-60.5 ... -58.0
	++	-20 ... <-15 or >+15 ... +20	>-58.0 ... -57.0
	+	-25 ... <-20 or >+20 ... +25	-61.0 ... <-60.5 or >-57.0 ... -56.0
	-	-30 ... <-25 or >+25 ... +30	-62.0 ... <-61.0 or >-56.0 ... -50.0
Clean the electrode according to the electrode operating manual			
<i>Error</i>	<i>Error</i>	<-30 or >+30	<-62.0 or >-50.0
Error elimination (see section 14 WHAT TO DO IF..., page 88)			

**Calibration record
(example)**

```
Multi 3320
Ser. no. 11292113

CALIBRATIONpH
15.02.2014 15:55

AutoCal TEC
Buffer 1          4.01
Buffer 2          7.00
Buffer 3         10.01
Voltage 1        184.0 mV
Voltage 2         3.0 mV
Voltage 3       -177.0 mV
Temperature 1    24.0 °C
Temperature 2    24.0 °C
Temperature 3    24.0 °C
Slope           -60.2 mV/pH
Asymmetry        4.0 mV
Sensor           +++

etc...
```

5.2.7 Continuous measurement control (CMC function)

The Continuous Measurement Control (CMC function) facilitates to evaluate the current measured value instantly and definitely.

After each successful calibration the scale of the pH measuring range is displayed in the measured value display. Here you can very clearly see whether or not the current measured value is in the calibrated part of the measuring range.

The following information is displayed:

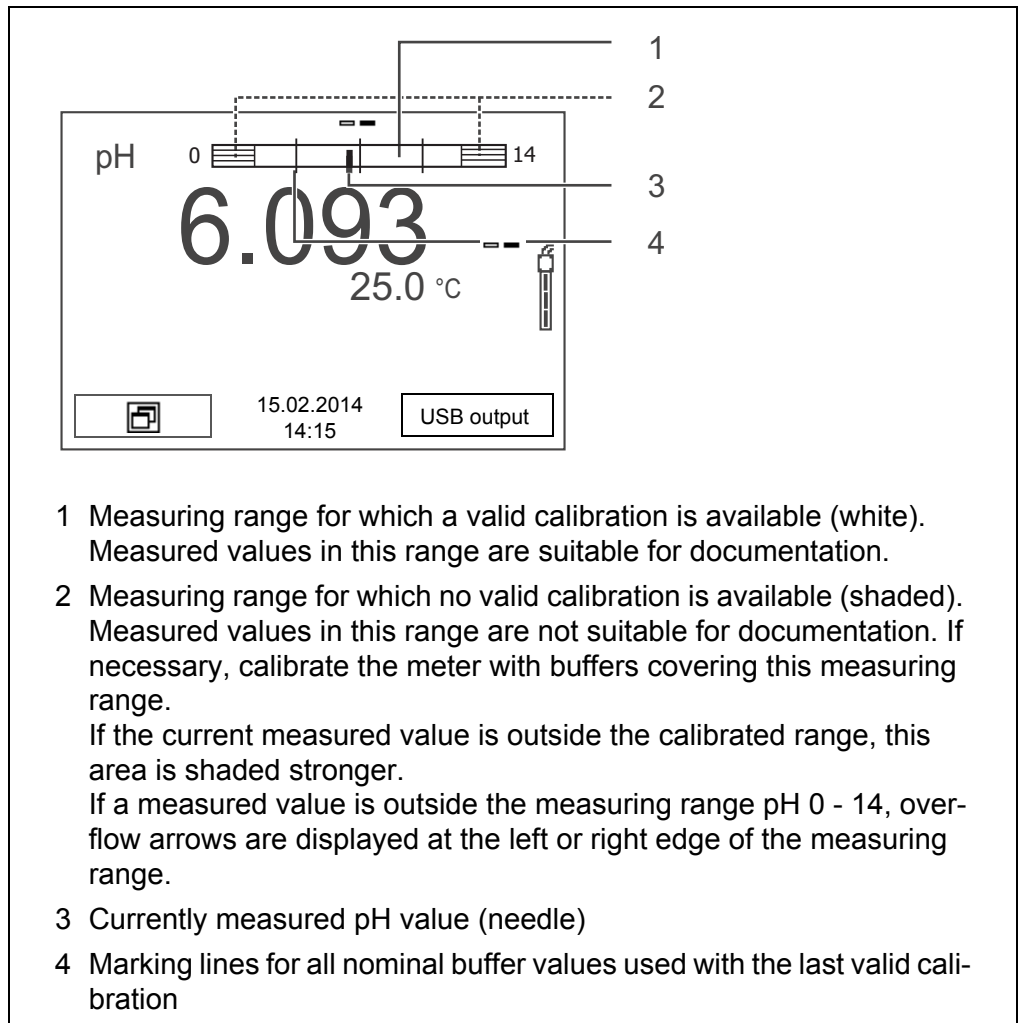

The limits of the calibrated range are determined by the buffers used for calibration:

Lower limit: Buffer with lowest pH value - 2 pH units
 Upper limit: Buffer with highest pH value + 2 pH units

6 ORP voltage

6.1 Measuring

6.1.1 Measuring the ORP

NOTE

When connecting an earthed PC/printer, measurements cannot be performed in earthed media as the values would be incorrect. The USB interface is not galvanically isolated.

1. Connect the ORP electrode to the meter.
2. If necessary, select the U (mV) display with <M>.
3. When measuring without temperature sensor:
 - Temper the test sample, or measure the current temperature.
 - Enter the temperature value in the menu.
4. Rinse the ORP electrode and immerse it in the test sample. The measured value is checked for stability (automatic stability control). The display of the measured parameter flashes.
5. Wait for a stable measured value. The display of the measured parameter no longer flashes.

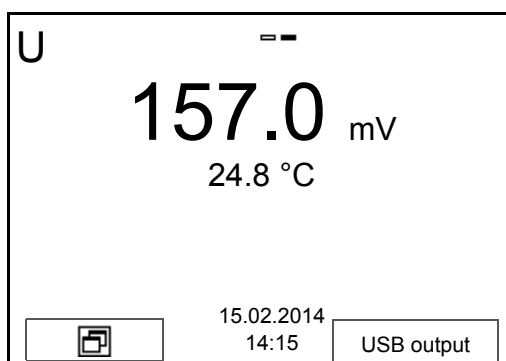

Stability control (AutoRead)

The stability control function (*AutoRead*) continually checks the stability of the measurement signal. The stability has a considerable impact on the reproducibility of measured values.

You can activate or switch off the automatic *Stability control* function (see section 10.2.1 SYSTEM, page 74).

The measured parameter flashes on the display

- as soon as the measured value is outside the stability range
- when you switch over between the measured parameters with <M>.
- when the automatic *Stability control* is switched off.

Criteria for a stable measured value

The *Stability control* function checks whether the measured values are stable within the monitored time interval.

Measured variable	Time interval	Stability in the time interval
ORP	15 seconds	Δ : better than 0.3 mV
Temperature	15 seconds	Δ : better than 0.5 °C

The minimum duration until a measured value is assessed as stable is the monitored time interval. The actual duration is mostly longer.

Manually starting the stability control

Irrespective of the setting for automatic *Stability control* (see section 10.2.1 SYSTEM, page 74) in the *System* menu, you can start the *Stability control* function manually at any time.

1. Freeze the measured value with **<AR>**.
The [HOLD] status indicator is displayed.
2. Using **<ENTER>**, activate the *Stability control* function manually.
The [AR] status indicator appears while the measured value is assessed as not stable. A progress bar is displayed and the display of the measured parameter flashes.
The [HOLD][AR] status indicator appears as soon as a stable measured value is recognized. The progress bar disappears and the display of the measured parameter stops flashing.
The current measurement data is output to the interface. Measurement data meeting the stability control criterion is marked by AR.



You can prematurely terminate the *Stability control* function manually with **<ENTER>** at any time. If the *Stability control* function is prematurely terminated, the current measurement data are output to the interface without the AutoRead info.

3. Using **<ENTER>**, start a further measurement with *Stability control*.
or
Release the frozen measured value again with **<AR>**.
The display switches to the measured value display.
The [AR][HOLD] status display disappears.

Freezing the measured value (HOLD function)

With the HOLD function, you can freeze the current measured value. The displayed measured value stops changing until you switch the HOLD function off.



If the HOLD function is active, you can, e.g. start a manual measurement with stability control.

1. Freeze the measured value with **<AR>**.
The [HOLD] status indicator is displayed.
2. Release the frozen measured value again with **<AR>**.
The HOLD function is switched off.
The [HOLD] status display disappears.

6.1.2 Measuring the temperature

For reproducible ORP measurements, it is essential to measure the temperature of the test sample.

You have the following options to measure the temperature:

- Automatic measurement of the temperature by the temperature sensor (NTC30 or Pt1000) integrated in electrode.
- Measurement by an external temperature sensor.
- Manual determination and input of the temperature.

The measuring instrument recognizes whether a suitable sensor is connected and automatically switches on the temperature measurement.

The display of the temperature indicates the active temperature measuring mode:

Temperature sensor	Resolution of the temp. display	Temp. measurement
yes	0.1 °C	Automatic with temperature sensor
-	1 °C	Manual

If you wish to measure without temperature sensor, proceed as follows:

1. Measure the current temperature of the test sample.
2. Set the temperature value with <▲><▼>.
 - or
 - In the <ENTER>/U/Man. temperature menu, set the temperature value with <▲><▼>.

6.2 ORP calibration



ORP electrodes are not calibrated. You can, however, check ORP electrodes by measuring the ORP of a test solution and comparing the value with the nominal value.

7 Ion concentration

7.1 Measuring

7.1.1 Measuring the ion concentration

NOTE

When connecting an earthed PC/printer, measurements cannot be performed in earthed media as the values would be incorrect. The USB interface is not galvanically isolated.



Incorrect calibration of ion sensitive electrodes will result in incorrect measured values. Calibrate regularly before measuring.



For precise ISE measurements the temperature difference between measurement and calibration should not be greater than 2 K. Therefore, adjust the temperature of the standard and measuring solutions accordingly. If the temperature difference is greater the [TempErr] warning appears in the measured value display.

1. Connect the ISE combination electrode to the meter. The pH/U/ISE measuring window is displayed.
2. If necessary, select the ISE display (unit, mg/l) with <M>.
3. When measuring without temperature sensor:
 - Temper the test sample, or measure the current temperature.
 - Enter the temperature value in the menu.
4. Calibrate or check the meter with the electrode.



While no valid calibration is available, e.g. in the delivery condition, "Error" appears in the measured value display.

5. Immerse the electrode in the test sample.

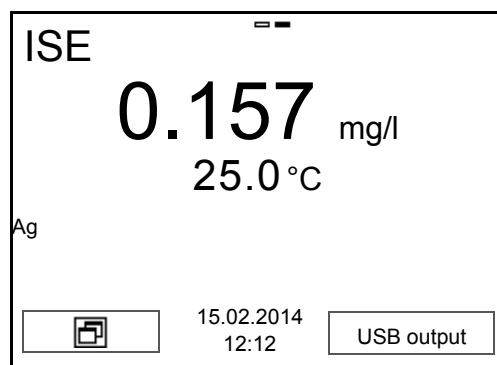

Stability control (AutoRead) & HOLD function

The stability control function (*AutoRead*) continually checks the stability of the measurement signal. The stability has a considerable impact on the reproducibility of measured values.

The measured parameter flashes on the display

- as soon as the measured value is outside the stability range
- when the automatic *Stability control* is switched off.

You can activate or switch off the automatic *Stability control* function (see section 10.2.1 SYSTEM, page 74).

1. Freeze the measured value with **<AR>**.
The [HOLD] status indicator is displayed.
The HOLD function is active.



You can terminate the *Stability control* function and the HOLD function with **<AR>** or **<M>** at any time.

2. Using **<ENTER>**, activate the *Stability control* function manually. The [AR] status indicator appears while the measured value is assessed as not stable. A progress bar is displayed and the display of the measured parameter flashes. The [HOLD][AR] status indicator appears as soon as a stable measured value is recognized. The progress bar disappears and the display of the measured parameter stops flashing. The current measurement data is output to the interface. Measurement data meeting the stability control criterion is marked by AR.



You can prematurely terminate the *Stability control* function manually with **<ENTER>** at any time. If the *Stability control* function is prematurely terminated, the current measurement data are output to the interface without the AutoRead info.

3. Using **<ENTER>**, start a further measurement with stability control.
or
Release the frozen measured value again with **<AR>** or **<M>**.
The [AR] status display disappears. The display switches back to the previous indication.

Criteria

The AutoRead criteria affect the reproducibility of the measured values. The following criteria can be adjusted:

- *high*: highest reproducibility
- *medium*: medium reproducibility
- *low*: lowest reproducibility



Increasing reproducibility also causes the response time to increase until a measured value is evaluated as stable.

7.1.2 Measuring the temperature

For reproducible ion-selective measurements, it is essential to measure the temperature of the test sample.

You have the following options to measure the temperature:

- Measurement by an external temperature sensor.
- Manual determination and input of the temperature.

The measuring instrument recognizes whether a suitable sensor is connected and automatically switches on the temperature measurement.

The display of the temperature indicates the active temperature measuring mode:

Tempera- ture sensor	Resolution of the temp. dis- play	Temp. measurement
yes	0.1 °C	Automatic with temperature sensor
-	1 °C	Manual

If you wish to measure (or calibrate) without temperature sensor, proceed as follows:

1. Measure the current temperature of the test sample.
2. When measuring without temperature sensor:
 - Temper the test sample, or measure the current temperature.
 - Enter the temperature value in the menu.

7.2 Calibration

7.2.1 Why calibrate?

Ion-selective electrodes age and are temperature-dependent. This changes the slope. As a result, an inexact measured value is displayed. Calibration determines the calibration line of the electrode and stores this value in the meter.

Thus, you should calibrate before each measurement and at regular intervals.

7.2.2 When to calibrate?

- Before any measurement if possible
- After connecting another ISE electrode
- When the sensor symbol flashes, e.g. after a voltage interruption (empty batteries)

7.2.3 Calibration (ISE Cal)

ISE Cal is the conventional **two-point to seven-point calibration procedure** that uses 2 to 7 freely selectable standard solutions. The concentration expected in the measurement determines the concentration of the calibration standards.

1. Connect the ISE combination electrode to the meter. The pH/U/ISE measuring window is displayed.
2. Keep the standard solutions ready.
3. When measuring without temperature sensor:
 - Temper the test sample, or measure the current temperature.
 - Enter the temperature value in the menu.
4. In the measured value display, select the ISE measuring window with **<▲>** **<▼>** and **<M>**.
5. If necessary, change the unit of the measurement result and calibration standards in the *ISE setup/Unit* menu.
6. Start the calibration with **<CAL>**. The calibration display appears.

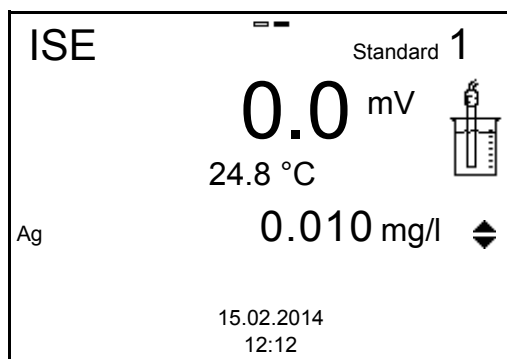

7. Thoroughly rinse the electrode with distilled water.
8. Immerse the electrode in standard solution 1.
9. When calibrating without temperature sensor:
 - Measure the temperature of the standard solution using a thermometer.
 - Use <F2>/[↑] to select the setting of the temperature.
 - Use <▲> <▼> to set the temperature.
 - Use <F2>/[↑] to select the setting of the concentration.
10. Set the concentration of the standard solution with <▲> <▼> and press <ENTER>.

The standard solution is measured.
The measured value is checked for stability (AutoRead).

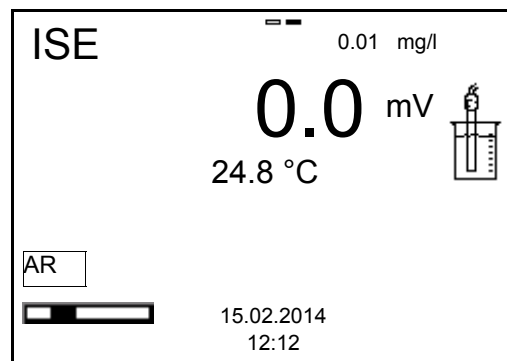

11. Wait for the end of the AutoRead measurement or accept the calibration value with <ENTER>.

The calibration display for the next standard solution appears.

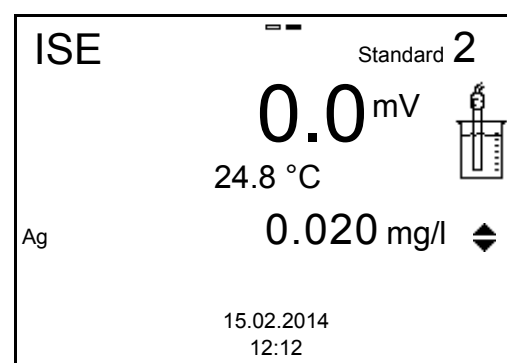

Continuing with two-point calibration

12. Thoroughly rinse the electrode with distilled water.
13. Immerse the electrode in standard solution 2.

14. When calibrating without temperature sensor:
 - Measure the temperature of the standard solution using a thermometer.
 - Use <F2>/[\updownarrow] to select the setting of the temperature.
 - Use <▲> <▼> to set the temperature.
 - Use <F2>/[\updownarrow] to select the setting of the concentration.
15. Set the concentration of the standard solution with <▲> <▼> and press <ENTER>.

The standard solution is measured.
The measured value is checked for stability (AutoRead).

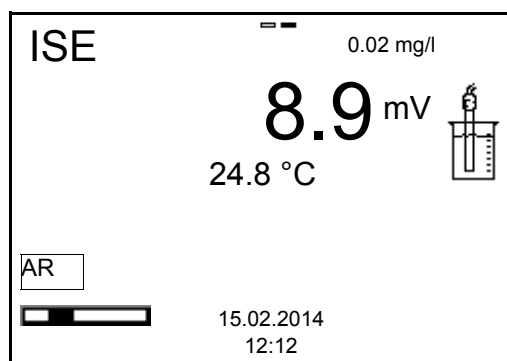

16. Wait for the end of the AutoRead measurement or accept the calibration value with <ENTER>.

The calibration display for the next standard solution appears.

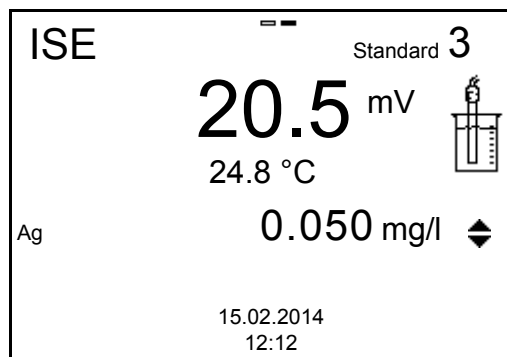

17. Press <ENTER> to continue with three-point calibration.
or
Finish the calibration procedure as a two-point calibration with <M>.

The new calibration values are displayed.

Continuing with three- to seven-point calibration

Repeat the steps 12 to 17 in the same way with the third and further standard solutions as necessary. The new calibration values are displayed after the last calibration step was completed.



Based on the calibration data, the calibration curve is determined in sections, according to the Nernst equation modified by Nikolski.

7.2.4 Calibration standards

Use two to seven different standard solutions. The standard solutions have to be selected in either increasing or decreasing order.



Select the unit of the standard solution and measurement result in the *ISE setup/Unit* menu.

Standard solution (Std 1 - 7)	Values
Unit [mg/l]	0.010 ... 500.000
Unit [mol/l]	0.100 ... 5.000 µmol/l 10.00 ... 5.000 mmol/l
Unit [mg/kg]	0.010 ... 500.000
Unit [ppm]	0.010 ... 500.000
Unit [%]	0.001 ... 50.000



The measurement precision is also dependent on the selected standard solutions. Therefore, the selected standard solutions should cover the value range expected of the following concentration measurement.

If the measured electrode potential is outside the calibrated range, the *[ISEErr]* warning is displayed.

7.2.5 Calibration data

Displaying the calibration data

The calibration record of the last calibration is to be found under the menu item, **<ENTER>** / *Calibration* / *Calibration record*. To open it, press the **<CAL__>** key in the measured value display.

Subsequently, you can transmit the displayed calibration data to the interface, e.g. to a PC, with the **<F2>**[*USB output*] key.

Displaying the calibration data storage

The calibration records of the last calibrations (up to 10) are given in the menu, **<ENTER>**/*Calibration* / *Calibration data storage*.

Menu item	Setting/function	Description
<i>Calibration / Calibration data storage / Display</i>	-	Displays the calibration record. Further options: <ul style="list-style-type: none"> ● Scroll through the calibration records with <▲><▼>. ● Output the displayed calibration record to the interface with <F2>/[USB output]. ● Quit the display with <F1>/[Back] or <ENTER>. ● Switch directly to the measured value display with <M>.
<i>Calibration / Calibration data storage / Output to USB</i>	-	Outputs the calibration records to the interface.

Calibration evaluation

After calibrating, the meter automatically evaluates the calibration.

Display	Calibration record	Magnitude of the slope [mV]
	+++	50.0 ... 70.0 or 25.0 ... 35.0
<i>Error</i> Error elimination (see section 13 WHAT TO DO IF..., page 89)	<i>Error</i>	< 50 or > 70 or < 25 or > 35

Calibration record (example)

```
Multi 3320
Ser. no. 12345678

CALIBRATIONISE
15.02.2014 08:09:10

Standard 1          0.010 mg/l
Standard 2          0.020 mg/l
Voltage 1           38.5 mV
Voltage 2           58.0 mV
Temperature 1       24.0 øC
Temperature 2       24.0 øC
Ion type            Ag
Slope               64.7 mV
Sensor              +++
```

8 Dissolved oxygen

8.1 Measuring

8.1.1 Measuring D.O.

NOTE

When connecting an earthed PC/printer, measurements cannot be performed in earthed media as the values would be incorrect. The USB interface is not galvanically isolated.

1. Connect the D.O. sensor to the meter.
The D.O. measuring screen is displayed.



D.O. measurements can be carried out with the CellOx 325 or DurOx 325 D.O. sensor.

The measuring instrument automatically recognizes the type of the connected D.O. sensor.

2. If necessary, select the measured parameter with **<M>**.
3. Immerse the D.O. sensor in the test sample.

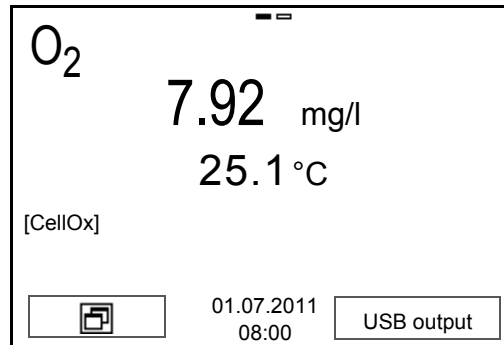

4. If necessary, select the measured parameter with **<M>**.
 - D.O. concentration [mg/l]
 - D.O. saturation [%]
 - D.O. partial pressure [mbar].

Salinity correction

When measuring the concentration of solutions with a salt content of more than 1 g/l, a salinity correction is required. For this, you have to measure and input the salinity of the measured medium first. When the salinity correction is switched on, the **[SAL]** indicator is displayed in the measuring window.



You can switch the salinity correction on or off and enter the salinity in the menu for calibration and measurement settings (see section 10.1.6 SETTINGS FOR D.O. SENSORS, page 68).

Stability control (AutoRead) & HOLD function

The stability control function (*AutoRead*) continually checks the stability of the measurement signal. The stability has a considerable impact on the reproducibility of measured values.

The measured parameter flashes on the display

- as soon as the measured value is outside the stability range
- when the automatic *Stability control* is switched off.

You can activate or switch off the automatic *Stability control* function (see section 10.1.6 SETTINGS FOR D.O. SENSORS, page 68).

1. Freeze the measured value with **<AR>**.
The [HOLD] status indicator is displayed.
The HOLD function is active.



You can terminate the *Stability control* function and the HOLD function with **<AR>** or **<M>** at any time.

2. Using **<ENTER>**, activate the *Stability control* function manually. The [AR] status indicator appears while the measured value is assessed as not stable. A progress bar is displayed and the display of the measured parameter flashes. The [HOLD][AR] status indicator appears as soon as a stable measured value is recognized. The progress bar disappears and the display of the measured parameter stops flashing. The current measurement data is output to the interface. Measurement data meeting the stability control criterion is marked by AR.



You can prematurely terminate the *Stability control* function manually with **<ENTER>** at any time. If the *Stability control* function is prematurely terminated, the current measurement data are output to the interface without the AutoRead info.

3. Using **<ENTER>**, start a further measurement with stability control.
or
Release the frozen measured value again with **<AR>** or **<M>**.
The [AR] status display disappears. The display switches back to the previous indication.

Criteria for a stable measured value

The *Stability control* function checks whether the measured values are stable

within the monitored time interval.

Measured variable	Time interval	Stability in the time interval
D.O. concentration	20 seconds	Δ : better than 0.05 mg/l
Oxygen saturation	20 seconds	Δ : better than 0.6 %
D.O. partial pressure	20 seconds	Δ : better than 1.2 mbar
Temperature	15 seconds	Δ : better than 0.5 °C

The minimum duration until a measured value is assessed as stable is the monitored time interval. The actual duration is mostly longer.

8.1.2 Measuring the temperature

For reproducible D.O. measurements, it is essential to measure the temperature of the test sample.

The temperature is automatically measured by the temperature sensor (NTC30 or Pt1000) integrated in the sensor.



The CelOx 325 and DurOx 325 D.O. sensors have an integrated temperature sensor.

8.2 Calibration

8.2.1 Why calibrate?

D.O. sensors age. This changes the slope of the D.O. sensor. Calibration determines the current slope of the sensor and stores this value in the instrument.

8.2.2 When to calibrate?

- After connecting a sensor
- Routinely within the framework of the company quality assurance
- When the calibration interval has expired

8.2.3 Calibration procedures

The Multi 3320 provides 2 calibration procedures:

- Calibration in water vapor-saturated air.
Use an OxiCal[®] air calibration vessel for calibration.
- Calibration via a comparison measurement (e.g. Winkler titration according to DIN EN 25813 or ISO 5813). At the same time, the relative slope is adapted to the comparison measurement by a correction factor. When the correction factor is active, the *[Factor]* indicator appears in the measuring window.

8.2.4 Calibration in water vapor-saturated air (air calibration vessel)

For this calibration procedure, the *Comparison meas.* setting must be set to *Off* in the *Calibration* menu.

Proceed as follows to calibrate the instrument:

1. Connect the D.O. sensor to the meter.
2. Put the D.O. sensor into the air calibration vessel.



The sponge in the air calibration vessel must be moist (not wet). Leave the sensor in the air calibration vessel for a time long enough to adjust.

3. Start the calibration with **<CAL>**.
The last calibration data (relative slope) is displayed.

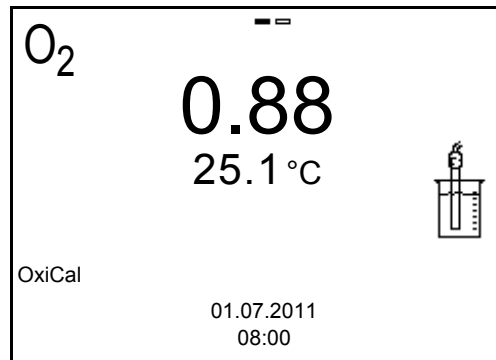

4. Start the measurement with **<ENTER>**.
The measured value is checked for stability (stability control).
The [AR] status indicator is displayed. A progress bar is displayed and the display of the measured parameter flashes.
5. Wait for the end of the measurement with stability control or accept the calibration value with **<ENTER>**.
The calibration record is displayed and output to the interface.
6. Using **<F1>**/*[Continue]* or **<ENTER>**, switch to the measured value display.
The meter displays a D.O. saturation of approx. 101.7 % in the air calibration vessel.

8.2.5 Calibrating with a Comparison meas. (OxiComp)

For this calibration procedure, the *Comparison meas.* setting must be set to *On* in the *Calibration* menu.



Before calibrating via a comparison measurement, the sensor should be calibrated in the air calibration vessel.

1. Connect the D.O. sensor to the meter.
2. Immerse the D.O. sensor in the reference solution.
3. Start the calibration with **<CAL>**.

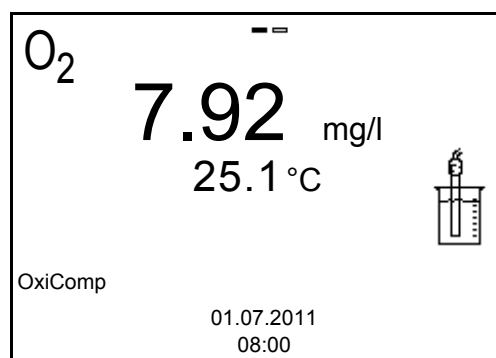

4. Start the measurement with **<ENTER>**.
The measured value is checked for stability (stability control).
The [AR] status indicator is displayed. The measured parameter flashes.
5. Wait for the end of the measurement with stability control or accept the calibration value with **<ENTER>**.
The factor that was set last is displayed.

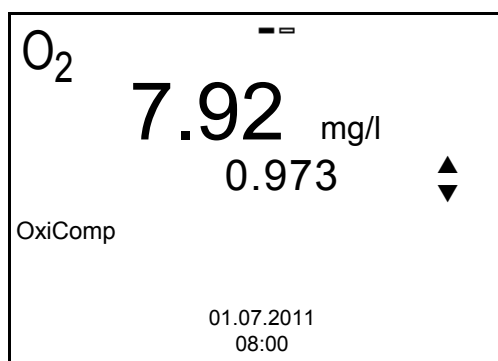

6. Using **<▲>** **<▼>**, set the correction factor to adjust the displayed concentration value to the nominal value (value of the comparison measurement). Subsequently, accept the correction factor with **<ENTER>**.
The meter switches to the measured value display.
The status display [*Factor*] is active.

8.2.6 Calibration data



The calibration record is automatically transmitted to the interface after calibrating.

Displaying the calibration data

The calibration record of the last calibration is to be found under the menu item, **<ENTER>** / *Calibration* / *Calibration record*. To open it, press the **<CAL__>** key in the measured value display.

Subsequently, you can transmit the displayed calibration data to the interface, e.g. to a PC, with the **<F2>**[*USB output*] key.



Displaying the calibration data storage

The calibration records of the last calibrations (up to 10) are available in the menu, **<ENTER>** / *Calibration* / *Calibration data storage* and in the menu, **<ENTER>** / *Storage & config* / *Data storage* / *Calibration data storage*.

Menu item	Setting/function	Description
<i>Calibration</i> / <i>Calibration data storage</i> / <i>Display</i> or <i>Data storage</i> / <i>Calibration data storage</i> / <i>Display</i>	-	Displays the calibration record. Further options: <ul style="list-style-type: none"> ● Scroll through the calibration records with <▲><▼>. ● Output the displayed calibration record to the interface with <F2>[<i>USB output</i>]. ● Quit the display with <F1> / [<i>Back</i>] or <ENTER>. ● Switch directly to the measured value display with <M>.
<i>Calibration</i> / <i>Calibration data storage</i> / <i>Output to USB</i> or <i>Data storage</i> / <i>Calibration data storage</i> / <i>Output to USB</i>	-	Outputs the calibration records to the interface.

Calibration evaluation

After calibration, the meter automatically evaluates the current status of the calibration. The evaluation appears on the display and in the calibration record.

Display	Calibration record	Relative slope
	+++	$S = 0.8 \dots 1.25$
	++	$S = 0.7 \dots 0.8$
	+	$S = 0.6 \dots 0.7$
<i>Error</i>	<i>Error</i>	$S < 0.6$ or $S > 1.25$
Error elimination (see section 11 WHAT TO DO IF..., page 48)		

Calibration record (example)

```
Multi 3320
Ser. no. 11292113

CALIBRATION Cellox
01.07.2011 16:13:33

S = 0.88 25.0 °C
Sensor +++
```

Calibration datasets

The Multi 3320 administrates two sets of calibration data:

- Set 1 for the type, "Cellox": – Cellox 325
- Set 2 for the type, "DurOx": – DurOx 325

Sensors of different types can be calibrated separately from each other. When one sensor type is calibrated, the calibration data of the other type remains stored. The Multi 3320 recognizes the type of the connected sensor and automatically uses the correct calibration data.

9 Conductivity

9.1 Measuring

9.1.1 Measuring the conductivity

NOTE

When connecting an earthed PC/printer, measurements cannot be performed in earthed media as the values would be incorrect. The USB interface is not galvanically isolated.

1. Connect the conductivity measuring cell to the measuring instrument. The conductivity measuring screen is displayed.
2. If necessary, select the measured parameter with **<M>**.
3. Check the *Measuring cell* settings and cell constant for the connected conductivity measuring cell. If necessary, correct the settings.



The selection of the measuring cell and the setting of the cell constant is done in the measurement settings menu for conductivity (see section 10.1.8 SETTINGS FOR CONDUCTIVITY MEASURING CELLS, page 70). The cell constant to be set must either be taken from the operating manual of the measuring cell or is printed on the measuring cell.

4. Immerse the conductivity measuring cell in the test sample.

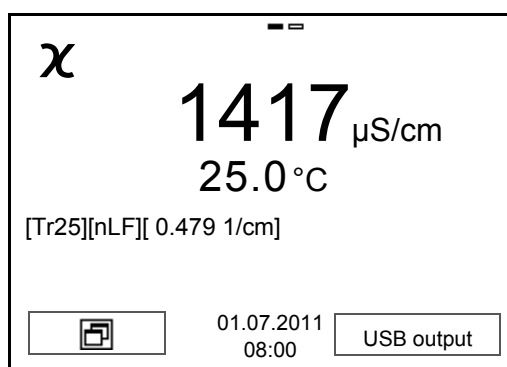

5. If necessary, select the measured parameter with **<M>**.
 - Conductivity [$\mu\text{S}/\text{cm}$] / [mS/cm]
 - Resistivity [$\Omega \cdot \text{cm}$] / [$\text{k}\Omega \cdot \text{cm}$] / [$\text{M}\Omega \cdot \text{cm}$]
 - Salinity SaL []
 - Total dissolved solids TDS [mg/l] / [g/l]



The factor to calculate the total dissolved solids is set to 1.00 in the factory. You can adjust this factor to meet your requirements in the range 0.40 ... 1.00. The factor is set in the *Measurement* menu for the parameter, TDS.

Stability control (AutoRead) & HOLD function

The stability control function (*AutoRead*) continually checks the stability of the measurement signal. The stability has a considerable impact on the reproducibility of measured values.

The display of the measured parameter flashes.

- as soon as the measured value is outside the stability range.
- when the automatic *Stability control* is switched off.

You can activate or switch off the automatic *Stability control* function (see section 10.1.8 SETTINGS FOR CONDUCTIVITY MEASURING CELLS, page 70).

1. Freeze the measured value with **<AR>**.
The [HOLD] status indicator is displayed.
The HOLD function is active.



You can terminate the *Stability control* function and the HOLD function with **<AR>** or **<M>** at any time.

2. Using **<ENTER>**, activate the *Stability control* function manually. The [AR] status indicator appears while the measured value is assessed as not stable. A progress bar is displayed and the display of the measured parameter flashes. The [HOLD][AR] status indicator appears as soon as a stable measured value is recognized. The progress bar disappears and the display of the measured parameter stops flashing. The current measurement data is output to the interface. Measurement data meeting the stability control criterion is marked by AR.



You can prematurely terminate the *Stability control* function manually with **<ENTER>** at any time. If the *Stability control* function is prematurely terminated, the current measurement data are output to the interface without the AutoRead info.

3. Using **<ENTER>**, start a further measurement with stability control.
or
Release the frozen measured value again with **<AR>** or **<M>**.
The [AR] status display disappears. The display switches back to the previous indication.

Criteria for a stable measured value

The *Stability control* function checks whether the measured values are stable

within the monitored time interval.

Measured variable	Time interval	Stability in the time interval
Conductivity χ	10 seconds	Δ : better than 1.0 % of measured value
Temperature	15 seconds	Δ : better than 0.5 °C

The minimum duration until a measured value is assessed as stable is the monitored time interval. The actual duration is mostly longer.

9.1.2 Measuring the temperature

For reproducible conductivity measurements, it is essential to measure the temperature of the test sample.

The temperature is automatically measured by the temperature sensor (NTC30 or Pt1000) integrated in the sensor.



The TetraCon 325, KLE 325, LR 325/01 and LR 325/001 conductivity sensors have an integrated temperature sensor.

9.2 Calibration

9.2.1 Why calibrate?

Aging slightly changes the cell constant, e.g. due to coatings. As a result, an inexact measured value is displayed. The original characteristics of the cell can often be restored by cleaning the cell. Calibration determines the current value of the cell constant and stores this value in the meter.

Thus, you should calibrate at regular intervals (we recommend: every 6 months).

9.2.2 When to calibrate?

- After connecting a sensor
- Routinely within the framework of the company quality assurance
- When the cleaning interval has expired

9.2.3 Determining the cell constant (calibration in control standard)

You can determine the actual cell constant of the conductivity measuring cell by calibrating with the control standard in the following ranges:

- 0.450 ... 0.500 cm^{-1}
(e.g. TetraCon 325 with a nominal cell constant of 0.475 $^{-1}$)
- 0.800 ... 0.880 cm^{-1}

(e.g. KLE 325 with a nominal cell constant of 0.840^{-1})

The cell constant is determined in the control standard, 0.01 mol/l KCl. Cell constants outside the ranges quoted above cannot be calibrated.

In the delivery condition, the calibrated cell constant of the meter is set to 0.475 cm^{-1} (conductivity measuring cell, TetraCon 325).

For this calibration procedure, the *Measuring cell* setting must be set to cal in the *Measurement* menu. Proceed as follows to determine the cell constant:

1. Connect the conductivity measuring cell to the measuring instrument.
2. In the measured value display, select the conductivity parameter with **<M>**.
3. Start the calibration with **<CAL>**.
The cell constant that was calibrated last is displayed.

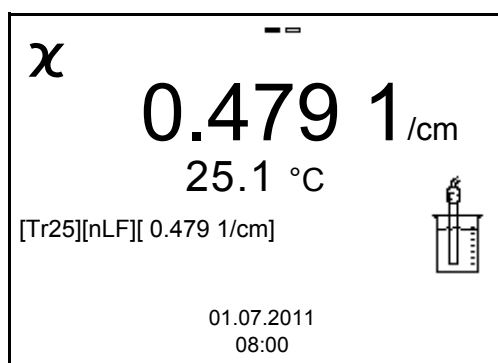

4. Immerse the conductivity measuring cell in the control standard solution, 0.01 mol/l KCl.
5. Start the measurement with **<ENTER>**.
The [AR] status indicator is displayed. A progress bar is displayed and the display of the measured parameter flashes.
6. Wait for the end of the measurement with stability control or accept the calibration value with **<ENTER>**.
The calibration record is displayed and output to the interface.
7. Using **<F1>** / *[Continue]* or **<ENTER>**, switch to the measured value display.

9.2.4 Calibration data



The calibration record is automatically transmitted to the interface after calibrating.

Displaying the calibration data

The calibration record of the last calibration is to be found under the menu item, **<ENTER>** / *Calibration* / *Calibration record*. To open it, press the **<CAL__>** key in the measured value display.

Subsequently, you can transmit the displayed calibration data to the interface, e.g. to a PC, with the **<F2>**[USB output] key.

Displaying the calibration data storage

The calibration records of the last calibrations (up to 10) are available in the menu, **<ENTER>** / Calibration / Calibration data storage and in the menu, **<ENTER>** / Storage & config/Data storage / Calibration data storage.

Menu item	Setting/function	Description
Calibration / Calibration data storage /Display or Data storage / Calibration data storage /Display	-	Displays the calibration record. Further options: <ul style="list-style-type: none"> ● Scroll through the calibration records with <▲><▼>. ● Output the displayed calibration record to the interface with <F2>[USB output]. ● Quit the display with <F1>[Back] or <ENTER>. ● Switch directly to the measured value display with <M>.
Calibration / Calibration data storage / Output to USB or Data storage / Calibration data storage / Output to USB	-	Outputs the calibration records to the interface.

Calibration evaluation

After calibration, the meter automatically evaluates the current status of the calibration. The evaluation appears on the display and in the calibration record.

Display	Calibration record	Cell constant [cm ⁻¹]
	+++	within the ranges 0.450 ... 0.500 cm ⁻¹ or 0.800 ... 0.880 cm ⁻¹
Error Error elimination (see section 11 WHAT TO DO IF..., page 48)	Error	outside the ranges 0.450 ... 0.500 cm ⁻¹ or 0.800 ... 0.880 cm ⁻¹

**Calibration record
(example)**

```
Multi 3320  
Ser. no. 11292113  
  
CALIBRATION Cond  
01.07.2011 16:13:33  
  
Cell constant 0.479 1/cm      25.0 °C  
Sensor                        +++
```

10 Settings

10.1 Measurement settings

10.1.1 Settings for pH measurements

The settings for pH measurements are made in the menu for calibration and measurement settings of the pH/ORP measurement. To open the settings, display the required measured parameter in the measured value display and press the **<ENTER>** key. After completing the settings, switch to the measured value display with **<M>**.

In the following table, only those settings are listed that concern the pH measurement.

Default settings are printed in **bold**.

Menu item	Possible setting	Description
<i>Calibration / Calibration record</i>	-	Displays the calibration record of the last calibration.
<i>Calibration / Calibration data storage / Display</i>	-	Displays the calibration record. Further options: <ul style="list-style-type: none"> ● Scroll through the calibration records with <▲><▼>. ● Output the displayed calibration record to the interface with <F2>/[USB output]. ● Output all calibration records to the interface with <F2__>/[USB output]. ● Quit the display with <F1>/[Back] or <ENTER>. ● Switch directly to the measured value display with <M>.
<i>Calibration / Calibration data storage / Output to USB</i>	-	Outputs the calibration records to the interface.
<i>Calibration / Buffer</i>	TEC NIST/DIN ConCal ...	Buffer sets to be used for pH calibration (see section 5.2 CALIBRATION, page 25).
<i>Calibration / One point calibration</i>	Yes No	Quick calibration with 1 buffer
<i>Calibration / Calibration interval</i>	1 ... 7 ... 999 d	<i>Calibration interval</i> for the pH electrode (in days). The meter reminds you to calibrate regularly by the flashing sensor symbol in the measuring screen.

Menu item	Possible setting	Description
<i>Calibration /Unit for slope</i>	mV/pH %	Unit of the slope. The % display refers to the Nernst slope of -59.2 mV/pH (100 x determined slope/Nernst slope).
<i>Alternative temperature</i>	<i>On</i> Off	Takes the temperature value from the 2nd sensor.
<i>Man. temperature</i>	-25 ... +25 ... +130 °C	Entry of the manually determined temperature. For measurements without temperature sensor only.
<i>Resolution pH</i>	0.001 0.01 0.1	Resolution of the pH display
<i>Reset</i>	-	Resets all sensor settings to the delivery condition (see section 10.3.1 RESETTING THE MEASUREMENT SETTINGS, page 75).

10.1.2 Buffer sets for calibration

You can use the buffer sets quoted in the table for an automatic calibration. The pH values are valid for the specified temperature values. The temperature dependence of the pH values is taken into consideration during the calibration.

No.	Buffer set *	pH values	at
1	<i>ConCal</i>	Any	Any
2	<i>NIST/DIN</i> DIN buffers according to DIN 19266 and NIST Traceable Buffers	1.679 4.006 6.865 9.180 12.454	25 °C
3	<i>TEC</i> WTW Technical buffers	2.000 4.010 7.000 10.011	25 °C
4	<i>Merck 1*</i>	4.000 7.000 9.000	20°C
5	<i>Merck 2 *</i>	1.000 6.000 8.000 13.000	20°C

No.	Buffer set *	pH values	at
6	<i>Merck 3 *</i>	4.660 6.880 9.220	20 °C
7	<i>Merck 4 *</i>	2.000 4.000 7.000 10.000	20 °C
8	<i>Merck 5 *</i>	4.010 7.000 10.000	25 °C
9	<i>DIN 19267</i>	1.090 4.650 6.790 9.230	25 °C
10	<i>Mettler Toledo USA *</i>	1.679 4.003 7.002 10.013	25 °C
11	<i>Mettler Toledo EU *</i>	1.995 4.005 7.002 9.208	25 °C
12	<i>Fisher *</i>	2.007 4.002 7.004 10.002	25 °C
13	<i>Fluka BS *</i>	4.006 6.984 8.957	25 °C
14	<i>Radiometer *</i>	1.678 4.005 7.000 9.180	25 °C
15	<i>Baker *</i>	4.006 6.991 10.008	25 °C
16	<i>Metrohm *</i>	3.996 7.003 8.999	25 °C
17	<i>Beckman *</i>	4.005 7.005 10.013	25 °C
18	<i>Hamilton Duracal *</i>	4.005 7.002 10.013	25 °C

No.	Buffer set *	pH values	at
19	<i>Precisa</i> *	3.996 7.003 8.999	25 °C
20	<i>Reagecon TEC</i> *	2.000 4.010 7.000 10.000	25 °C
21	<i>Reagecon 20</i> *	2.000 4.000 7.000 10.000 13.000	20°C
22	<i>Reagecon 25</i> *	2.000 4.000 7.000 10.000 13.000	25 °C
23	<i>Chemsolute</i> *	2.000 4.000 7.000 10.000	20°C
24	<i>USABlueBook</i> *	4.000 7.000 10.000	25 °C
25	<i>YSI</i> *	4.000 7.000 10.000	25 °C

Brand names or trade names are trademarks of their respective owners protected by law.



The buffers are selected in the menu, pH / **<ENTER>** / *Calibration* / *Buffer* (see 10.1.1 SETTINGS FOR PH MEASUREMENTS, PAGE 61).

10.1.3 Calibration interval

The calibration evaluation is displayed as a sensor symbol.

The sensor symbol flashes after the adjusted calibration interval has expired. It is still possible to measure.



To ensure the high measuring accuracy of the measuring system, calibrate after the calibration interval has expired.

Setting the calibration interval

The calibration interval is set to 7 days in the factory. You can change the interval (1 ... 999 days):

1. Using **<ENTER>**, open the menu for the measurement settings.
2. In the *Calibration / Calibration interval* menu, set the calibration interval with **<▲><▼>**.
3. Confirm the setting with **<ENTER>**.
4. Quit the menu with **<M>**.

10.1.4 Settings for ORP measurements

The settings for ORP measurements are made in the menu for calibration and measurement settings of the pH/ORP measurement. To open the settings, display the required measured parameter in the measured value display and press the **<ENTER>** key. After completing the settings, switch to the measured value display with **<M>**.

In the following table, only those settings are listed that influence the ORP measurement.

Default settings are printed in **bold**.

Menu item	Possible setting	Description
<i>Man. temperature</i>	-25 ... +25 ... +130 °C	Entry of the manually determined temperature. For measurements without temperature sensor only.
<i>Resolution mV</i>	0.1 1	Resolution of the mV display
<i>Reset</i>	-	Resets all sensor settings to the delivery condition (see section 10.3.1 RESETTING THE MEASUREMENT SETTINGS, page 75).

10.1.5 Settings for ISE measurements

The settings for ISE measurements are made in the menu for calibration and measurement settings of the ISE measurement.

To open the settings, display the required measured parameter in the measured value display and press the **<ENTER>** key. After completing the settings, switch to the measured value display with **<M>**.

In the following table, only those settings are listed that influence the ISE measurement:

Menu item	Possible setting	Description
<i>Calibration / Calibration record</i>	-	Displays the calibration record of the last calibration.
<i>Calibration / Calibration data storage / Display</i>	-	Displays the calibration record. Further options: <ul style="list-style-type: none"> ● Scroll through the calibration records with <▲><▼>. ● Output the displayed calibration record to the interface with <F2>/[USB output]. ● Output all calibration records to the interface with <F2__>[USB output]. ● Quit the display with <F1>/[Back] or <ENTER>. ● Switch directly to the measured value display with <M>.
<i>Calibration / Calibration data storage / Output to USB</i>	-	Outputs the calibration records to the interface.
<i>Man. temperature</i>	-25 ... +25 ... +130 °C	Entry of the manually determined temperature. For measurements without temperature sensor only.
<i>ISE setup / AutoRead criterion</i>	<i>low</i> <i>medium</i> high	Selection of the AutoRead criteria (see section 7.1.1 MEASURING THE ION CONCENTRATION, page 39).

Menu item	Possible setting	Description
<i>ISE setup / Ion type</i>	Ag, Br, Ca, Cd, Cl, CN, Cu, F, I, K, Na, NO ₃ , Pb, S, NH ₃ , NH ₄ , CO ₂ , ION * Measuring with the NH 500 electrode: The NH ₄ setting is not suitable for the gas-sensitive electrode NH 500. Select the following settings: <i>Ion type "ION", Valency "-1"</i> .	Selection of the ion type to be measured. An ion that is not included in the list can be measured with the setting, ION.
<i>ISE setup / Unit</i>	mg/l µmol/l mg/kg ppm %	Selection, with which unit the measurement result and calibration standards should be displayed.
<i>ISE setup / Ion type/ION</i>	<i>Valency</i> <i>Molar mass</i>	Set the valence (<i>Valency</i>) and molar weight (<i>Molar mass</i>) for the ion.
<i>ISE setup / Density</i>	0.001 ... 9.999 g/ml or kg/l	Adjustable density of the test sample (only with <i>Unit</i> : mg/kg, ppm, %)

10.1.6 Settings for D.O. sensors

The settings are available in the menu for measurement and calibration settings. To open the settings, display the required measured parameter in the measured value display and press the **<ENTER>** key. After completing the settings, switch to the measured value display with **<M>**.

Default settings are printed in **bold**.

Menu item	Possible setting	Description
<i>Calibration / Calibration record</i>	-	Displays the calibration record of the last calibration.
<i>Calibration / Calibration data storage / Display</i>	-	Displays the calibration record. Further options: <ul style="list-style-type: none"> ● Scroll through the calibration records with <▲><▼>. ● Output the displayed calibration record to the interface with <F2>/[USB output]. ● Output all calibration records to the interface with <F2__>[USB output]. ● Quit the display with <F1>/[Back] or <ENTER>. ● Switch directly to the measured value display with <M>.
<i>Calibration / Calibration data storage / Output to USB</i>	-	Outputs the calibration records to the interface.
<i>Calibration / Calibration interval</i>	1 ... 14 ... 999 d	<i>Calibration interval</i> for the D.O. sensor (in days). The meter reminds you to calibrate regularly by the flashing sensor symbol in the measuring screen.
<i>Calibration / Comparison meas.</i>	On Off	Enables to adjust the measured value with the aid of a comparison measurement, e.g. Winkler titration. For details, see section 8.2 CALIBRATION, page 50.

Menu item	Possible setting	Description
<i>Sal correction</i>	<i>On</i> <i>Off</i>	Manual salt content correction for concentration measurements.
<i>Salinity</i>	0.0 ... 70.0	Salinity or salinity equivalent for the salt content correction. This function is only available for concentration measurements if the manual salt content correction is switched on.
<i>Reset</i>	-	Resets all sensor settings to the delivery condition (see section 10.3.1 RESETTING THE MEASUREMENT SETTINGS, page 75).

10.1.7 Calibration interval

The calibration evaluation is displayed as a sensor symbol.

The sensor symbol flashes after the adjusted calibration interval has expired. It is still possible to measure.



To ensure the high measuring accuracy of the measuring system, calibrate after the calibration interval has expired.

Setting the calibration interval

The calibration interval is set to 14 days in the factory. You can change the interval (1 ... 999 days):

1. Open the menu for measurement settings with **<ENTER>**.
2. In the *Calibration / Calibration interval* menu, set the calibration interval with **<▲><▼>**.
3. Confirm the setting with **<ENTER>**.
4. Quit the menu with **<M>**.

10.1.8 Settings for conductivity measuring cells

The settings are made in the *Measurement* menu for the measured parameter, conductivity. To open the settings, display the required measured parameter in the measured value display and press the **<ENTER>** key. After completing the settings, switch to the measured value display with **<M>**.

Default settings are printed in **bold**.

Menu item	Possible setting	Description
<i>Calibration / Calibration record</i>	-	Displays the calibration record of the last calibration.
<i>Calibration / Calibration data storage / Display</i>	-	Displays the calibration record. Further options: <ul style="list-style-type: none"> ● Scroll through the calibration records with <▲><▼>. ● Output the displayed calibration record to the interface with <F2>/[USB output]. ● Output all calibration records to the interface with <F2__>[USB output]. ● Quit the display with <F1>/[Back] or <ENTER>. ● Switch directly to the measured value display with <M>.
<i>Calibration / Calibration data storage / Output to USB</i>	-	Outputs the calibration records to the interface.
<i>Calibration / Calibration interval</i>	1 ... 150 ... 999 d	<i>Calibration interval</i> for the measuring cell (in days). The meter reminds you to calibrate regularly by the flashing sensor symbol in the measuring screen.

Menu item	Possible setting	Description
<i>Measurement / Measuring cell / Type</i>	<p>Cal</p> <p><i>LR325/01</i></p> <p><i>LR325/001</i></p> <p><i>man</i></p>	<p><i>Measuring cell used</i></p> <p>Measuring cells whose cell constant is determined by calibration in the KCL control standard solution. Calibration ranges: 0.450 ... 0.500 cm⁻¹ and 0.800 ... 0.880 cm⁻¹ The currently valid cell constant is displayed in the status line.</p> <p><i>LR 325/01 measuring cell, nominal cell constant 0.100 cm⁻¹. The cell constant can be adjusted in the range 0.090 ... 0.110 cm⁻¹.</i></p> <p><i>LR 325/001 measuring cell, nominal cell constant 0.010 cm⁻¹. The cell constant is permanently set.</i></p> <p>Any measuring cells with freely adjustable cell constants in the range 0.250 ... 25.000 cm⁻¹.</p>
<i>Measurement / Measuring cell / Cell const. man</i>	0.250 ... 0.475 25.000 cm ⁻¹	Display and setting option of the cell constant of any measuring cells (man).
<i>Measurement / Measuring cell / Cell const. LR325/ 01</i>	0.090 ... 0.100 ... 0.110 cm ⁻¹	Display and setting option of the cell constant of the LR 325/01 measuring cell.
<i>Measurement / Temp. comp. (TC) /Method</i>	nLF <i>Lin</i> <i>Off</i>	Procedure for temperature compensation (see section 10.1.10 TEMPERATURE COMPENSATION, page 72). This setting is only available for the measured parameters, χ and ρ .
<i>Measurement / Temp. comp. (TC) / Linear coeff.</i>	0.000 ... 2.000 ... 10.000 %/K	Coefficient of the linear temperature compensation. This setting is only available when the linear temperature compensation is set.

Menu item	Possible setting	Description
<i>Measurement / Temp. comp. (TC) / Reference temp.</i>	20 °C 25 °C	Reference temperature This setting is only available for the measured parameters, x and p .
<i>Measurement / TDS factor</i>	0.40 ... 1.00	Factor for TDS value
<i>Reset</i>	-	Resets all sensor settings to the delivery condition (see section 10.3.1 RESETTING THE MEASUREMENT SETTINGS, page 75).

10.1.9 Calibration interval

The calibration evaluation is displayed as a sensor symbol.

The sensor symbol flashes after the adjusted calibration interval has expired. It is still possible to measure.



To ensure the high measuring accuracy of the measuring system, calibrate after the calibration interval has expired.

Setting the calibration interval

The calibration interval is set to 150 days in the factory. You can change the interval (1 ... 999 days):

1. Open the menu for measurement settings with **<ENTER>**.
2. In the *Calibration / Calibration interval* menu, set the calibration interval with **<▲><▼>**.
3. Confirm the setting with **<ENTER>**.
4. Quit the menu with **<M>**.

10.1.10 Temperature compensation

The calculation of the temperature compensation is based on the preset reference temperature, 20 °C or 25 °C. It appears on the display as Tr20 or Tr25.

You can select one of the following temperature compensation methods:

- **Nonlinear temperature compensation (nLF)** according to EN 27 888
- **Linear temperature compensation (lin)** with adjustable coefficient in the range 0.000 ... 10.000 %/K
- **No temperature compensation (off)**



The reference temperature and temperature compensation are set in the *Measurement* menu for the parameter, conductivity (see section 10.1.8 SETTINGS FOR CONDUCTIVITY MEASURING CELLS, page 70).

Application tips Set the temperature compensation suitable for your test sample:

Test sample	Temperature compensation	Display
Natural water (ground water, surface water, drinking water)	<i>nLF</i> according to EN 27 888	<i>nLF</i>
Ultrapure water	<i>nLF</i> according to EN 27 888	<i>nLF</i>
Other aqueous solutions	<i>Lin</i> Set linear temperature coefficient 0.000 ... 10.000 %/K	<i>Lin</i>
Salinity (seawater)	Automatic <i>nLF</i> according to IOT (International Oceanographic Tables)	<i>Sal, nLF</i>

10.1.11 Setting the TDS factor

The factor to calculate the total dissolved solids is set to 1.00 in the delivery condition.

You can adjust this factor to meet your requirements in the range 0.40 ... 1.00.

The factor is set in the menu for the parameter TDS (*Measurement / TDS factor*).

10.2 Sensor-independent settings

10.2.1 System

To open the *Storage & config* menu in the measured value display, press the **<ENTER__>** key. After completing the settings, switch to the measured value display with **<M>**.

Default settings are printed in **bold**.

Menu item	Possible setting	Description
<i>System / General / Language</i>	<i>Deutsch</i> English <i>(further)</i>	Selects the menu language
<i>System / General / Beep</i>	On Off	Switch on/off the beep on key-stroke
<i>System / General / Illumination</i>	Auto On Off	Switches the display illumination on/off
<i>System / General / Contrast</i>	0 ... 50 ... 100 %	Changes the display contrast
<i>System / General / Switchoff time</i>	10 min ... 1h ... 24 h	Adjusts the switch-off time
<i>System / General / Temperature unit</i>	°C °F	Temperature unit, degrees Celsius or degrees Fahrenheit. All temperature values are displayed with the selected unit.
<i>System / General / Stability control</i>	On Off	Switches on or off the automatic stability control during measurement
<i>System / Interface / Baud rate</i>	1200, 2400, 4800 , 9600, 19200	Baud rate of the data interface
<i>System / Interface / Output format</i>	ASCII CSV	Output format for data transmission (see section 12 TRANSMITTING DATA (USB INTERFACE), page 84)
<i>System / Interface / Decimal separator</i>	Dot (xx.x) Comma (xx,x)	Decimal separator
<i>System / Interface / Output header</i>		Output of a header for <i>Output format</i> : CSV

Menu item	Possible setting	Description
<i>System /Clock</i>	<i>Date format</i> <i>Datum</i> <i>Time</i>	Time and date settings (see section 4.4.6 EXAMPLE 2 ON NAVIGATION: SETTING THE DATE AND TIME, page 19)
<i>System /Service information</i>		Hardware version and software version of the meter are displayed.
<i>System /Reset</i>	-	Resets the system settings to the delivery condition (see section 10.3.2 RESETTING THE SYSTEM SETTINGS, page 77).

10.2.2 Data storage

This menu contains all functions to display, edit and erase stored measured values and calibration records (see section 11 DATA STORAGE, page 78).

10.3 Reset

You can reset (initialize) all sensor settings and sensor-independent settings separately from each other.

10.3.1 Resetting the measurement settings



The calibration data are reset to the default settings together with the measuring parameters. Recalibrate after performing a reset.

The following settings for pH measurements are reset to the default settings with the *Reset* function:

pH	Setting	Default settings
	<i>Buffer</i>	<i>TEC</i>
	<i>Calibration interval</i>	7 d
	<i>Unit for slope</i>	mV/pH
	<i>Measured parameter</i>	pH
	Resolution pH	0.001
	Resolution mV	0.1
	Asymmetry	0 mV

Setting	Default settings
Slope	-59.2 mV
<i>Man. temperature</i>	25 °C
<i>One point calibration</i>	No

The sensor settings are reset under the *Reset* menu item in the menu for calibration and measurement settings. To open it in the measured value display, press the **<ENTER>** (or **<F1>/[Menu]**) key.

Oxi



The calibration data are reset to the default settings together with the measuring parameters. Recalibrate after performing a reset.

The following settings for D.O. measurements are reset to the default settings with the *Reset* function:

Setting	Default settings
Kal.-Intervall	14 d
Comparison meas.	Off
<i>Measured parameter</i>	D.O. concentration
<i>Relative slope (S_{Rel})</i>	1.00
<i>Salinity (value)</i>	0.0
<i>Salinity (function)</i>	Off

The sensor settings are reset under the *Reset* menu item in the menu for calibration and measurement settings. To open it in the measured value display, press the **<ENTER>** (or **<F1>/[Menu]**) key.

Cond

The following settings for conductivity measurements are reset to the default settings with the *Reset* function:

Setting	Default settings
<i>Kal.-Intervall</i>	150 d
<i>Measured parameter</i>	χ
<i>Cell constant (C)</i> <i>(calibrated)</i>	0.475 cm ⁻¹ or 0.840 cm ⁻¹ (nominal cell constant of the conductivity measuring cell last calibrated)
<i>Cell constant (C)</i> <i>(set)</i>	0.475 cm ⁻¹
<i>Temperature compensation</i>	nLF

Setting	Default settings
<i>Reference temperature</i>	25 °C
<i>Temperature coefficient (TC) of the linear temperature compensation</i>	2.000 %/K
<i>TDS factor</i>	1.00

The sensor settings are reset under the *Reset* menu item in the menu for calibration and measurement settings. To open it in the measured value display, press the **<ENTER>** (or **<F1>/[Menu]**) key.

10.3.2 Resetting the system settings

The following system settings can be reset to the default condition:

Setting	Default settings
<i>Language</i>	English
<i>Beep</i>	On
<i>Baud rate</i>	4800 Baud
<i>Output format</i>	ASCII
<i>Decimal separator</i>	Dot (xx.x)
<i>Contrast</i>	50 %
<i>Illumination</i>	Auto
<i>Switchoff time</i>	1 h
Stability control	On
Temperature unit	°C

The system settings are reset in the menu, *Storage & config / System / Reset*. To open the *Storage & config* menu in the measured value display, press the **<ENTER__>** (or **<F1__>/[Menu]**) key.

11 Data storage

You can transmit measured values (datasets) to the data storage:

- Manual data storage (see section 11.1 MANUAL STORAGE, page 78)
- Automatic storage at intervals (see section 11.2 AUTOMATIC DATA STORAGE AT INTERVALS, page 79)



With each data storage process, the current datasets of the sensors indicated on the display are transmitted to the interface at the same time.

11.1 Manual storage

You can transmit a measurement dataset to the data storage as follows. Bei jedem Speichervorgang werden die aktuellen Datensätze der im Display angezeigten Sensoren gleichzeitig auf die Schnittstelle übertragen.

1. Press the **<STO>** key shortly.
The menu for manual data storage appears.

Manual data storage 4 von 500

15.02.2014 11:24:16
 pH 7.000 24.8 °C AR +++
 O2 7.80 mg/l 24.8 °C AR +++

ID number: 1

Continue

Back
15.02.2014
14:15
USB output

2. If necessary, change and confirm the ID number (1 ... 10000) with **<▲><▼>** and **<ENTER>**.
The dataset is stored. The meter switches to the measured value display.

If the storage is full The following window appears if all 500 storage locations are occupied:

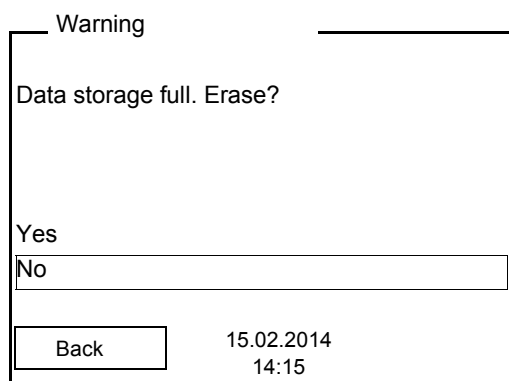

You have the following options:

- To erase the entire storage, confirm **Yes**.
- To cancel the storage process and switch to the measured value display, confirm **No**. Then you can e.g. transmit the stored data to a PC (see section 11.3.1 EDITING THE MEASURED VALUE STORAGE, page 81) and subsequently erase the data storage (see section 11.3.2 ERASING THE MEASUREMENT DATA STORAGE, page 83).

11.2 Automatic data storage at intervals

The storage interval (*Interval*) determines the time interval between automatic data storage processes. With each data storage process, the current datasets of the sensors indicated on the display are transmitted to the interface at the same time.

Configuring the automatic storage function

1. Press the **<STO__>** key.
The menu for automatic data storage appears.

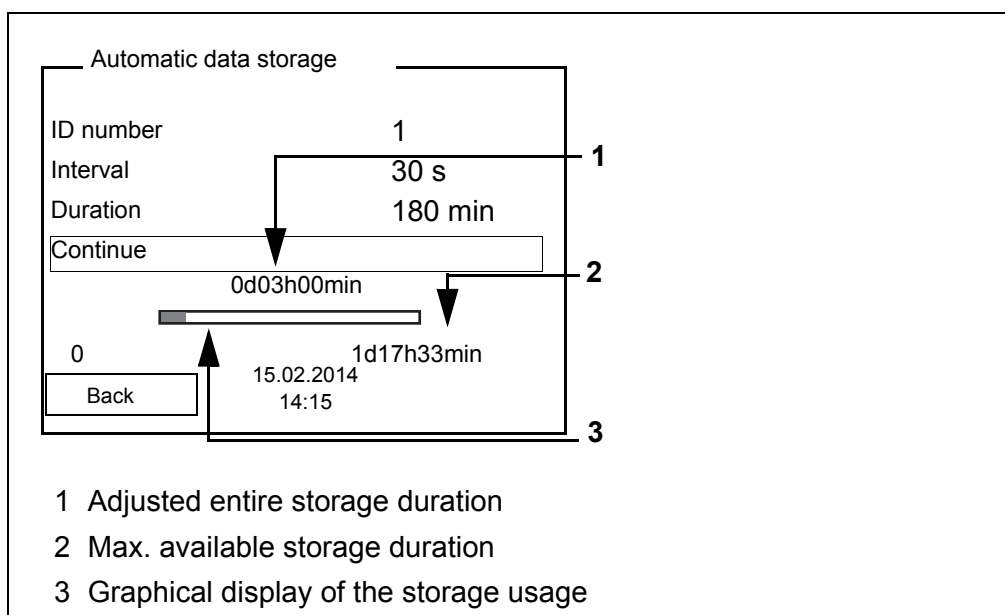

Settings You can configure the automatic data storage function with the following settings:

Menu item	Possible setting	Description
<i>ID number</i>	1 ... 10000	ID number for the dataset series.
<i>Interval</i>	1 s, 5 s, 10 s, 30 s, 1 min, 5 min, 10 min, 15 min, 30 min, 60 min	Storage interval. The lower limit of the storage interval can be restricted by the number of free storage locations. The upper limit is restricted by the storage duration.
<i>Duration</i>	1 min ... x min	Storage duration. Specifies after which time the automatic data storage should be terminated. The lower limit of the storage duration is restricted by the storage interval. The upper limit is restricted by the number of free storage locations.

Starting the automatic storage function

To start the automatic storage function, select *Continue* with <▲><▼> and confirm with <ENTER>. The meter switches to the measured value display.

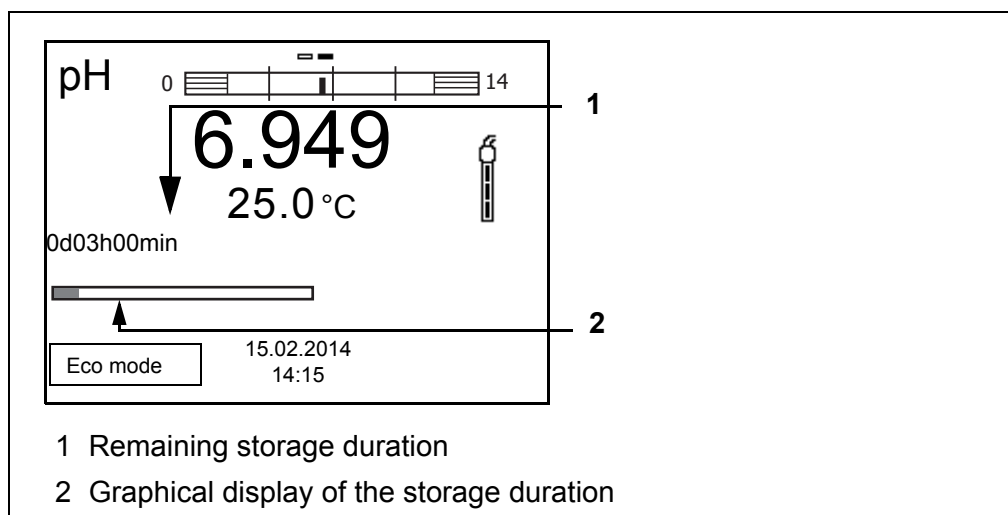

The active automatic storage function can be recognized by the progress bar in the function display. The progress bar indicates the remaining storage duration.



If the automatic storage function is activated, only the following keys are active: Softkeys, <M>, <STO__> and <On/Off>. The other keys and the automatic switch-off function are deactivated.

Energy saving mode ([Eco mode])

If the automatic storing function is active, the meter provides an energy saving mode ([Eco mode]) to avoid unnecessary energy consumption. The energy

saving mode switches off functions of the meter that are not required for the automatic storage of measurement data (such as the display). By pressing any key the energy saving mode is switched off again.

Terminating the automatic storage function prematurely

Proceed as follows to switch off the automatic data storage function before the adjusted storage duration has expired:

1. Press the **<STO__>** key.
The following window appears.

The image shows a rectangular dialog box with a title bar that says "Warning". Inside the box, the text "Stop automatic storage?" is displayed. Below this text are two options: "Yes" and "No". The "No" option is currently selected, indicated by a horizontal line under it. At the bottom left of the dialog box is a button labeled "Back". At the bottom right, the date and time "15.02.2014 14:15" are displayed.

2. Using **<▲><▼>**, select Yes and confirm with **<ENTER>**.
The meter switches to the measured value display.
The automatic data storage function is terminated.

11.3 Measurement data storage

11.3.1 Editing the measured value storage

The contents of the manual or automatic measurement data storage can be shown on the display and output to the interface.

Each of the measurement data storages has a function to erase the entire contents.

Editing the data storage

The storage is edited in the menu, *Storage & config/ Data storage*. To open the *Storage & config* menu in the measured value display, press the **<ENTER__>** key.

Open the manual or automatic storage directly with the **<RCL>** or **<RCL__>** key.



The settings are explained here using the manual data storage as an example. The same settings and functions are available for the automatic data storage.

Settings

Menu item	Setting/ function	Description
<i>Data storage / Manual data storage / Display</i>	-	Displays all measurement datasets page by page. Further options: <ul style="list-style-type: none"> ● Scroll through the datasets with <▲><▼>. ● Output the displayed dataset to the interface with <F2>/[USB output]. ● Quit the display with <F1>/[Back].
<i>Data storage / Manual data storage / Erase</i>	-	Erases the entire manual measurement data storage. All calibration data remain stored when this action is performed.
<i>Data storage / Manual data storage / Output to USB</i>	-	Outputs all stored measurement data to the interface.

Display presentation of a dataset

Manual data storage	3 of 64	◆
15.02.2014 11:24:16 ID number: 2		
pH 7.000 24.8 °C AR +++		
O2 7.80 mg/l 24.8 °C AR +++		
Back	15.02.2014 14:15	USB output

Representation of a dataset (USB output)

15.02.2014 09:56:20 Multi 3320 Ser. no. 08502113
ID number 2
pH1 6.012 24.8 °C, AR, S: +++ O2 7.80 24.8 °C, AR, S: +++

15.02.2014 10:56:20 Multi 3320 Ser. no. 08502113
ID number 2
pH1 6.012 24.8 °C, AR, S: +++ O2 7.80 24.8 °C, AR, S: +++

Quitting the display

To quit the display of stored measurement datasets, you have the following

options:

- Switch directly to the measured value display with **<M>**.
- Quit the display and move to the next higher menu level with **<F1>/[Back]**.

11.3.2 Erasing the measurement data storage

Erasing the measurement data storage (see section 11.3.1 EDITING THE MEASURED VALUE STORAGE, page 81).

11.3.3 Measurement dataset

A complete dataset includes:

- ID number
- Date/time
- Measured values of the connected sensors
- Measured temperature value of the connected sensors or manually set temperature
- AutoRead info: The *AR* indicator appears with the measured value if the AutoRead criterion was met while storing (stable measured value). Otherwise, there is no *AR* indicator.
- Calibration evaluation: +++, ++, +, -, or no evaluation

11.3.4 Storage locations

The Multi 3320 meter has two measurement data storages. The measured values recorded either manually or automatic are stored separately in individual measurement data storages.

Storage	Maximum number of datasets
<i>Manual data storage</i>	500
<i>Automatic data storage</i>	5000

12 Transmitting data (USB interface)

12.1 Options for data transmission

Via the USB interface you can transmit data to a PC. The following table shows which data are transmitted to the interface in which way:

Data	Control	Operation / description
Current datasets of the sensors indicated on the display	Manual	<ul style="list-style-type: none"> ● With <F2>/<i>[USB output]</i>. ● Simultaneously with every manual data storage process (see section 11.1 MANUAL STORAGE, page 78).
	Automatic, at intervals	<ul style="list-style-type: none"> ● With <F2__>/<i>[USB output]</i>. Then you can set the transmission interval. ● Simultaneously with every automatic data storage process (see section 11.2 AUTOMATIC DATA STORAGE AT INTERVALS, page 79).
Stored measured values	Manual	<ul style="list-style-type: none"> ● Displayed dataset with <F2>/<i>[USB output]</i> after calling up from the storage. ● All datasets with the <i>Output to USB</i> function. (see section 11.3.1 EDITING THE MEASURED VALUE STORAGE, page 81).
calibration records	Manual	<ul style="list-style-type: none"> ● Calibration record with <F2>/<i>[USB output]</i> (see section 5.2.6 CALIBRATION DATA, page 32).
	automatic	<ul style="list-style-type: none"> ● At the end of a calibration procedure.



The following rule applies: With the exception of the menus, shortly pressing the **<F2>**/*[USB output]* key generally outputs the display contents to the interface (displayed measured values, measurement datasets, calibration records).

12.2 Connecting a PC

Connect the Multi 3320 to the PC via the USB interface.

NOTE

When connecting an earthed PC/printer, measurements cannot be performed in earthed media as the values would be incorrect. The USB interface is not galvanically isolated.

Installation of the USB driver on the PC

System requirements of the PC for installation of the USB driver:

- PC with Pentium processor or higher with at least one free USB connection and CD-ROM drive
- Windows XP, Windows 7.

1. Insert the supplied installation CD in the CD drive of your PC.
2. Install the driver from the CD.
Follow the Windows installation instructions as necessary.
3. Connect the Multi 3320 to the PC via the USB interface.
The meter is listed as a virtual COM interface among the connections in the Windows instrument manager.

12.3 MultiLab Importer

With the aid of the MultiLab Importer software, you can record and evaluate measurement data with a PC.



More detailed information can be found in the MultiLab Importer operating manual.

13 Maintenance, cleaning, disposal

13.1 Maintenance

13.1.1 General maintenance activities

The only maintenance activity required is replacing the batteries.



See the relevant operating manuals of the electrodes for instructions on maintenance.

13.1.2 Replacing the batteries



You can operate the meter either with normal batteries or with rechargeable batteries (Ni-MH). In order to charge the batteries, an external charging device is required.

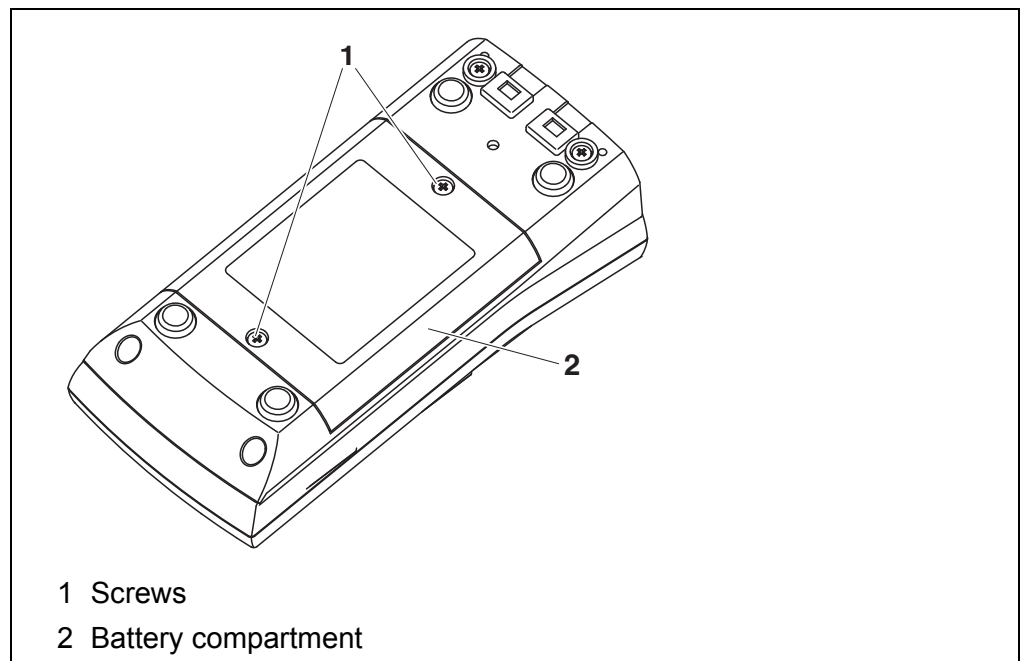

1. Unscrew the two screws (1) on the underside of the meter.
2. Open the battery compartment (2) on the underside of the meter.
3. Remove the four batteries from the battery compartment.
4. Place four new batteries (type Mignon AA) in the battery compartment.



CAUTION

Make sure that the poles of the batteries are positioned correctly. The \pm signs on the batteries must correspond to the \pm signs in the battery compartment.

5. Close the battery compartment (2) and tighten the screws (1).
6. Set the date and time (see section 4.4.6 EXAMPLE 2 ON NAVIGATION: SETTING THE DATE AND TIME, page 19)



When the batteries are nearly discharged, the  status indicator is displayed.



Dispose of used batteries according to the local regulations of your country.

End users within the European Union are obligated to return used batteries (even ecologically compatible ones) to a collection point set up for recycling purposes.

Batteries are marked with the crossed-out waste container symbol. Therefore, they may not be disposed with the domestic waste.

13.2 Cleaning

Occasionally wipe the outside of the measuring instrument with a damp, lint-free cloth. Disinfect the housing with isopropanol as required.



CAUTION

The housing is made of synthetic material (ABS). Thus, avoid contact with acetone or similar detergents that contain solvents. Remove any splashes immediately.

13.3 Packing

This meter is sent out in a protective transport packing.

We recommend: Keep the packing material. The original packing protects the meter against damage during transport.

13.4 Disposal

At the end of its operational lifetime, the meter must be returned to the disposal or return system statutory in your country. If you have any questions, please contact your supplier.

14 What to do if...

14.1 pH/ORP



More information and instructions on cleaning and exchange of sensors are given in the documentation of your sensor.

Error message
OFL, UFL

The measured value is outside the measuring range.

Cause	Remedy
Electrode:	
– Air bubble in front of the junction	– Remove air bubble
– Air in the junction	– Extract air or moisten junction
– Cable broken	– Replace electrode
– Gel electrolyte dried out	– Replace electrode
– The measured value is outside the measuring range of the meter	– Use suitable combination electrode

Error message,
Error

Cause	Remedy
Electrode:	
– The values determined for zero point and slope of the combination electrode are outside the allowed limits.	– Recalibrate
– Junction contaminated	– Clean junction
– Electrode broken	– Replace electrode
Buffer solutions:	
– Incorrect buffer solutions	– Change calibration procedure
– Buffer solutions too old	– Use only once. Note the shelf life
– Buffer solutions depleted	– Change solutions

No stable measured value	Cause	Remedy
	Electrode:	
	– Junction contaminated	– Clean junction
	– Membrane contaminated	– Clean membrane
	Test sample:	
	– pH value not stable	– Measure with air excluded if necessary
	– Temperature not stable	– Temper if necessary
	Electrode + test sample:	
	– Conductivity too low	– Use suitable combination electrode
	– Temperature too high	– Use suitable combination electrode
– Organic liquids	– Use suitable combination electrode	
Obviously incorrect measured values	Cause	Remedy
	Electrode:	
	– Electrode unsuitable	– Use suitable combination electrode
	– Temperature difference between buffer and test sample too great	– Adjust temperature of buffer or sample solutions
– Measurement procedure not suitable	– Follow special procedure	

14.2 ISE

Error message *OFL*

Cause	Remedy
– Measuring range exceeded	– Dilute test sample

Obviously incorrect measured values

Cause	Remedy
– Electrode not connected	– Connect electrode
– Cable broken	– Replace electrode

Error message, Error (invalid calibration)

Cause	Remedy
<i>ISE electrode:</i>	
– Moisture in the plug	– Dry plug
– Electrode obsolete	– Replace electrode
– Electrode unsuitable for the range to be measured	– Use suitable combination electrode
– Electrode not suitable for the selected ion	– Use a suitable electrode or select a suitable ion
– The gas-sensitive electrode NH 500 was calibrated with the <i>Ion type</i> setting	– Select the following settings: <i>Ion type</i> = ION, <i>Valency</i> = -1
– Socket damp	– Dry socket
<i>Calibration procedure:</i>	
– Calibration standards do not have the correct temperature (max. ± 2 °C temperature difference)	– Adjust the temperature of the calibration standards

Warning [*TpErr*]

Cause	Remedy
– Temperature difference between measurement and calibration greater than 2 K.	– Adjust the temperature of the test sample

Warning [*ISEErr*]

Cause	Remedy
– Electrode voltage outside calibrated range	– Recalibrate

14.3 Dissolved oxygen



More information and instructions on cleaning and exchange of sensors are given in the documentation of your sensor.

Error message
OFL, UFL

The measured value is outside the measuring range.

Cause

- The measured value is outside the measuring range of the meter

Remedy

- Use a suitable D.O. sensor

Error message,
Error

Cause

- D.O. sensor contaminated
- Electrolyte depleted

Remedy

- Clean the D.O. sensor
- Change the electrolyte and membrane cap
- If necessary, replace the D.O. sensor

Error message
Leak

Cause

- Membrane cap not screwed on tight enough
- Hole in the membrane

Remedy

- Screw membrane head tighter
- Replace and refill the membrane cap

14.4 Conductivity



More information and instructions on cleaning and exchange of sensors are given in the documentation of your sensor.

Error message *OFL, UFL*

The measured value is outside the measuring range.

Cause	Remedy
<ul style="list-style-type: none"> – The measured value is outside the measuring range of the meter 	<ul style="list-style-type: none"> – Use suitable measuring cell

Error message, *Error*

Cause	Remedy
<ul style="list-style-type: none"> – Measuring cell contaminated 	<ul style="list-style-type: none"> – Clean cell and replace it if necessary
<ul style="list-style-type: none"> – Calibration solution not suitable 	<ul style="list-style-type: none"> – Check the calibration solutions

14.5 General information

Sensor symbol flashes	Cause <ul style="list-style-type: none"> – Calibration interval expired 	Remedy <ul style="list-style-type: none"> – Recalibrate the measuring system
 Display	Cause <ul style="list-style-type: none"> – Batteries almost empty 	Remedy <ul style="list-style-type: none"> – Replace the batteries (see section 13.1 MAINTENANCE, page 86)
Meter does not react to keystroke	Cause <ul style="list-style-type: none"> – Operating condition undefined or EMC load unallowed 	Remedy <ul style="list-style-type: none"> – Processor reset: Press the <ENTER> and <On/Off> key simultaneously
You want to know which software version is in the meter	Cause <ul style="list-style-type: none"> – E.g., a question by the service department 	Remedy <ul style="list-style-type: none"> – Switch on the meter. Open the menu, <ENTER__> / <i>Storage & config</i> / <i>System</i> / <i>Service information</i>. The instrument data are displayed.

15 Technical data

15.1 Measuring ranges, resolution, accuracy

15.1.1 pH/ORP

Measuring ranges, resolution

Parameter	Measuring range	Resolution
pH	-2.0 ... +20.0	0.1
	-2.00 ... +20.00	0.01
	- 2.000 ... + 19.999	0.001
U [mV]	-1200.0 ... +1200.0	0.1
	-2500 ... +2500	1
T [°C]	-5.0 ... +105.0	0.1
T [°F]	23.0 ... +221.0	0.1

Manual temperature input

Parameter	Range	Increment
T _{manual} [°C]	-25 ... +130	1
T _{manual} [°F]	-13 ... +266	1

Accuracy (± 1 digit)

Parameter	Accuracy	Temperature of the test sample
pH / range *		
-2.0 ... +20.0	± 0.1	+15 °C ... +35 °C
-2.00 ... +20.00	± 0.01	+15 °C ... +35 °C
- 2.000 ... + 19.999	± 0.005	+15 °C ... +35 °C
U [mV] / range		
-1200.0 ... +1200.0	± 0.3	+15 °C ... +35 °C
-2500 ... +2500	± 1	+15 °C ... +35 °C
T [°C] / temperature sensor		
NTC 30	± 0.1	
PT 1000	± 0.1	

* when measuring in a range of ± 2 pH around a calibration point



The accuracy values specified here apply exclusively to the meter. The accuracy of the electrodes and buffer solutions has to be taken into account additionally.

15.1.2 ISE

Measuring ranges,
resolution

Parameter	Measuring range	Resolution
ISE [mg/l]	0.000 ... 9.999	0.001
	10.00 ... 99.99	0.01
	100.0 ... 999.9	0.1
	1000 ... 999999	1
ISE [μ mol/l]	0.000 ... 9.999	0.001
	10.00 ... 99.99	0.01
	100.0 ... 999.9	0.1
	1000 ... 999999	1
[mmol/l]	1000 ... 999999	1
ISE [mg/kg]	0.000 ... 9.999	0.001
	10.00 ... 99.99	0.01
	100.0 ... 999.9	0.1
	1000 ... 999999	1
ISE [ppm]	0.000 ... 9.999	0.001
	10.00 ... 99.99	0.01
	100.0 ... 999.9	0.1
	1000 ... 999999	1
ISE [%]	0.000 ... 9.999	0.001
	10.00 ... 99.99	0.01
	100.0 ... 999.9	0.1
	1000 ... 999999	1

Manual
temperature input

Parameter	Range	Increment
T _{manual} [°C]	- 20 ... + 130	1

15.1.3 Oxi

Measuring ranges,
resolution

The values quoted in brackets apply especially to the DurOx 325 sensor.

Parameter	Measuring range	Resolution
Concentration [mg/l]	0 ... 20.00 (0 ... 20.0)	0.01 (0.1)
	20.0 ... 90.0	0.1 (1)
	(20 ... 90)	
Saturation [%]	0 ... 200.0 (0 ... 600)	0.1 (1)
	0 ... 600	1
D.O. partial pressure [mbar]	0 ... 200.0 (0 ... 1250)	0.1 (1)
	0 ... 1250	1
T [°C]	0 ... 50.0	0.1

Accuracy (± 1 digit)

Parameter	Accuracy
Concentration [mg/l]	± 0.5 % of measured value at ambient temperature of $+5$ °C ... $+30$ °C
Saturation [%]	± 0.5 % of measured value when measuring in the range of ± 10 K around the calibration temperature
D.O. partial pressure [mbar]	± 0.5 % of measured value at ambient temperature of $+5$ °C ... $+30$ °C
T [°C] / temperature sensor	
NTC 30	± 0.1
PT 1000	± 0.1

Correction functions

Temperature compensation	Accuracy better than 2 % at 0 ... $+40$ °C
Salinity correction	0 ... 70.0 SAL
Air pressure correction	Automatic through integrated pressure sensor in the range of 500 ... 1100 mbar



The accuracy values specified here apply exclusively to the meter. The accuracy of the D.O. sensors has also to be taken into account.

15.1.4 Cond

Measuring ranges,
resolution

Parameter	Measuring range	Resolution
x [$\mu\text{S}/\text{cm}$]	0.000 ... 1.999*	0.001
	0.00 ... 19.99**	0.01
	0.0 ... 199.9	0.1
	200 ... 1999	1
x [mS/cm]	2.00 ... 19.99	0.01
	20.0 ... 199.9	0.1
	200 ... 1000	1
ρ (Resistivity) [$\text{Ohm}\cdot\text{cm}$]	1.000 ... 1.999	0.001
	2.00 ... 19.99	0.01
	20.0 ... 199.9	0.1
	200 ... 1999	1
ρ (Resistivity) [$\text{kOhm}\cdot\text{cm}$]	2.00 ... 19.99	0.01
	20.0 ... 199.9	0.1
	200 ... 1999	1
ρ (Resistivity) [$\text{MOhm}\cdot\text{cm}$]	2.00 ... 19.99**	0.01
	20.0 ... 199.9*	0.1
SAL	0.0 ... 70.0 according to the IOT table	0.1
TDS	0 ... 1999 mg/l	1
	2.00 ... 19.99 g/l	0.01
	20.0 ... 199.9 g/l	0.1
T [$^{\circ}\text{C}$]	-5.0 ... +105.0	0.1
T [$^{\circ}\text{F}$]	+23.0 ... +221.0	0.1

* only possible with cells of the cell constant, 0.010 cm^{-1}

** only possible with cells of the cell constant, 0.010 cm^{-1} or $0.090 \dots 0.110 \text{ cm}^{-1}$

Cell constants

Cell constant C	Values
Can be calibrated in the ranges	$0.450 \dots 0.500 \text{ cm}^{-1}$
	$0.800 \dots 0.880 \text{ cm}^{-1}$
Adjustable	$0.090 \dots 0.110 \text{ cm}^{-1}$
	0.010 cm^{-1} (fixed)
	$0.250 \dots 25.000 \text{ cm}^{-1}$

Reference temperature

Reference temperature	Values
Adjustable	$20 \text{ }^{\circ}\text{C}$ (Tref20)
	$25 \text{ }^{\circ}\text{C}$ (Tref25)

Accuracy (± 1 digit)

Parameter	Accuracy	Temperature of the test sample
x and ρ / Temperature compensation		
None (Off)	$\pm 0.5 \%$	
Nonlinear (nLF)	$\pm 0.5 \%$	0 °C ... + 35 °C according to EN 27 888
	$\pm 0.5 \%$	+35 °C ... + 50 °C enhanced nLF function
Linear (lin)	$\pm 0.5 \%$	+10 °C ... + 75 °C
SAL / range		
0.0 ... 42.0	± 0.1	+5 °C ... +25 °C
	± 0.2	+25 °C ... +30 °C
TDS [mg/l]		
	$\pm 0.5 \%$	
T [°C] / temperature sensor		
NTC 30	± 0.1	
PT 1000	± 0.1	



The accuracy values specified here apply exclusively to the meter. The accuracy of the measuring cell has also to be taken into account.



Further data are given in the documentation of your sensor.

15.2 General data

Dimensions	Multi 3320:	Approx. 180 x 80 x 55 mm
Weight	Multi 3320:	Approx. 0.4 kg
Mechanical structure	Type of protection	IP 67
Electrical safety	Protective class	III
Test certificates	CE, cETLus	
Ambient conditions	Storage	-25 °C ... +65 °C
	Operation	+5 °C ... +55 °C
	Admissible relative humidity	Yearly mean: < 75 % 30 days/year: 95 % Other days: 85 %
Power supply	Batteries	4 x 1.5 V alkali-manganese batteries, type AA
	Rechargeable batteries	4 x 1.2 V NiMH rechargeable batteries, type AA (no charging function)
	Operational life	Up to 1000 h without / 150 h with illumination
pH sensor input	Input resistance	> 5 * 10 ¹² ohm
	Input current	< 1 * 10 ⁻¹² A
USB interface	Type	USB 1.1 USB B (device), data output
	Baud rate	Adjustable: 1200, 2400, 4800, 9600, 19200 Baud
	Data bits	8
	Stop bits	2
	Parity	None
	Handshake	RTS/CTS
	Cable length	Max. 3 m
Applicable directives and standards	EMC	EC directive 2004/108/EC EN 61326-1 EN 61000-3-2 EN 61000-3-3 FCC Class A
	Meter safety	EC directive 2006/95/EC EN 61010-1 UL 61010-1 CAN/CSA-C22.2#61010-1
	IP protection class	EN 60529

16 Firmware update

Available firmware updates are provided on the Internet.

With the firmware update program and a PC you can update the firmware of the Multi 3320 to the newest version.

For the update you have to connect the meter to a PC.

For the update via the USB interface, the following is required:

- a free USB interface (virtual COM port) on the PC
- the driver for the USB interface (on the enclosed CD-ROM)
- the USB cable (included in the scope of delivery of the Multi 3320).

1. Install the downloaded firmware update on a PC.
An update folder is created in the Windows start menu.
If an update folder already exists for the meter (or meter type), the new data is displayed there.
2. In the windows start menu, open the update folder and start the firmware update program.
3. Using the USB interface cable, connect the Multi 3320 to a USB interface (virtual COM port) of the PC.
4. Switch on the Multi 3320.
5. In the firmware update program, start the update process with OK.
6. Follow the instructions of the firmware update program.
During the programming process, a corresponding message and a progress bar (in %) are displayed.
The programming process takes approx. three minutes. A terminatory message is displayed after a successful programming process. The firmware update is completed.
7. Disconnect the Multi 3320 from the PC.
The Multi 3320 is ready for operation again.

After switching the meter off and on you can check whether the meter has taken over the new software version (see YOU WANT TO KNOW WHICH SOFTWARE VERSION IS IN THE METER, PAGE 93).

17 Glossary

pH/ORP/ISE

Asymmetry	see zero point
Junction	The junction is a porous body in the housing wall of reference electrodes or electrolyte bridges. It arranges the electrical contact between two solutions and makes the electrolyte exchange more difficult. The expression, junction, is also used for ground or junction-less transitions.
Electromotive force of a combination electrode	The electromotive force U of the combination electrode is the measurable electromotive force of an electrode in a solution. It equals the sum of all the galvanic voltages of the combination electrode. Its dependency on the pH results in the electrode function, which is characterized by the parameters, slope and zero point.
Zero point	The zero point of a pH combination electrode is the pH value at which the electromotive force of the pH combination electrode at a specified temperature is zero. Normally, this is at 25 °C.
pH value	The pH value is a measure of the acidic or basic effect of an aqueous solution. It corresponds to the negative decadic logarithm of the molal hydrogen ions activity divided by the unit of the molality. The practical pH value is the value of a pH measurement.
Potentiometry	Name of a measuring technique. The signal (depending on the measured parameter) of the electrode is the electrical potential. The electrical current remains constant.
ORP voltage	The ORP is caused by oxidizing or reducing substances dissolved in water if these substances become effective on an electrode surface (e.g. a gold or platinum surface).
Slope	The slope of a linear calibration function.

Dissolved oxygen

OxiCal®	WTW name for a procedure to calibrate D.O. measuring systems in water vapor saturated air.
Salinity	The absolute salinity S_A of seawater corresponds to the relationship of the mass of dissolved salts to the mass of the solution (in g/Kg). In practice, this dimension cannot be measured directly. Therefore, the practical salinity according to IOT is used for oceanographic monitoring. It is determined by measuring the electrical conductivity.
Salt content	General designation for the quantity of salt dissolved in water.
Oxygen partial pressure	Pressure caused by the oxygen in a gas mixture or liquid.
Oxygen saturation	Short name for the relative D. O. saturation.

Slope (relative) Designation used by WTW in the D.O. measuring technique. It expresses the relation of the slope value to the value of a theoretical reference probe of the same construction type.

Conductivity

Conductivity Short form of the expression, specific electrical conductivity. It corresponds to the reciprocal value of the resistivity. It is a measured value of the ability of a substance to conduct an electric current. In water analysis, the electrical conductivity is a dimension for the ionized substances in a solution.

Reference temperature Fixed temperature value to compare temperature-dependent measured values. For conductivity measurements, the measured value is converted to a conductivity value at a reference temperature of 20 °C or 25 °C.

Salinity The absolute salinity S_A of seawater corresponds to the relationship of the mass of dissolved salts to the mass of the solution (in g/Kg). In practice, this dimension cannot be measured directly. Therefore, the practical salinity according to IOT is used for oceanographic monitoring. It is determined by measuring the electrical conductivity.

Salt content General designation for the quantity of salt dissolved in water.

Temperature coefficient Value of the slope α of a linear temperature function.

$$\mathcal{R}_{T_{\text{Ref}}} = \mathcal{R}_{\text{Meas}} * \frac{1}{1 + \alpha * (T - T_{\text{Ref}})}$$

Temperature compensation Name of a function that considers the temperature influence on the measurement and converts it accordingly. Depending on the measured parameter to be determined, the temperature compensation functions in different ways. For conductimetric measurements, the measured value is converted to a defined reference temperature. For potentiometric measurements, the slope value is adjusted to the temperature of the test sample but the measured value is not converted.

Resistance Short name for the specific electrolytic resistance. It corresponds to the reciprocal value of the electrical conductivity.

Cell constant C Characteristic quantity of a conductivity measuring cell, depending on the geometry.

General information

Resolution Smallest difference between two measured values that can be displayed by a meter.

AutoRange Name of the automatic selection of the measuring range.

Adjusting	To manipulate a measuring system so that the relevant value (e.g. the displayed value) differs as little as possible from the correct value or a value that is regarded as correct, or that the difference remains within the tolerance.
Calibration	Comparing the value from a measuring system (e.g. the displayed value) to the correct value or a value that is regarded as correct. Often, this expression is also used when the measuring system is adjusted at the same time (see adjusting).
Channel	A channel is a display indication that corresponds to a physical connection on the meter.
Measured variable	The measured parameter is the physical dimension determined by measuring, e.g. pH, conductivity or D.O. concentration.
Test sample	Designation of the test sample ready to be measured. Normally, a test sample is made by processing the original sample. The test sample and original sample are identical if the test sample was not processed.
Measured value	The measured value is the special value of a measured parameter to be determined. It is given as a combination of the numerical value and unit (e.g. 3 m; 0.5 s; 5.2 A; 373.15 K).
Molality	Molality is the quantity (in Mol) of a dissolved substance in 1000 g solvent.
Reset	Restoring the original condition of all settings of a measuring system.
Stability control (AutoRead)	Function to control the measured value stability.
Standard solution	The standard solution is a solution where the measured value is known by definition. It is used to calibrate a measuring system.
Temperature function	Name of a mathematical function expressing the temperature behavior of a test sample, a sensor or part of a sensor.

18 Index

A

Air calibration beaker	50
Automatic switch-off function	15
AutoRead	48, 56
ORP	36
pH	22, 40

B

Battery compartment	11, 86
---------------------	--------

C

Calibration	
ISE	42
pH	25, 38
Calibration evaluation	53, 59
ISE	46
pH	33
Calibration interval	64, 69, 72
Calibration points	
pH	31
Comparison measurement (D.O.)	50
Connecting a PC	85
Control standard	58
Copyright	2

D

Dataset	83
Date and time	19
Default settings	
Measured parameter	75, 76
System settings	77
Display	13

E

Energy saving mode	80
--------------------	----

F

Firmware update	100
-----------------	-----

I

Initial commissioning	10
Initialize	75
Interval for calibration	64, 69, 72

K

Keys	12
------	----

M

Measured value display	16
------------------------	----

Measurement accuracy	64, 69, 72
Measurement data storage	
Edit	81
Erase	81
Storage locations	83
Measurement dataset	83
Measuring	47, 55
ISE	39
ORP	36
pH	22
Menus (navigation)	16
Messages	17

P

pH buffer sets	62
Print	84

R

Reset	75
-------	----

S

Scope of delivery	10
Single-point calibration	
pH	26, 30
Slope	
ISE	42
pH	25
Slope, relative	50
Socket field	14
Storage interval	79
Storing in memory	78
Automatic	79
Manual	78

T

TDS factor	73
Temperature compensation	72
Temperature measurement	49
ISE	41
pH	24, 38
Three-point calibration	
ISE	44
pH	27, 31
Transmitting data	84
automatic	84
Manual	84
Transmitting measured values	84
Two-point calibration	
ISE	43
pH	26, 30

Z

Zero point of pH electrode25

Xylem |'zīləm|

- 1) The tissue in plants that brings water upward from the roots;
- 2) a leading global water technology company.

We're 12,500 people unified in a common purpose: creating innovative solutions to meet our world's water needs. Developing new technologies that will improve the way water is used, conserved, and re-used in the future is central to our work. We move, treat, analyze, and return water to the environment, and we help people use water efficiently, in their homes, buildings, factories and farms. In more than 150 countries, we have strong, long-standing relationships with customers who know us for our powerful combination of leading product brands and applications expertise, backed by a legacy of innovation.

For more information on how Xylem can help you, go to www.xylem.com



Wissenschaftlich-Technische Werkstätten GmbH

Dr.-Karl-Slevogt-Straße 1
D-82362 Weilheim
Germany

Tel: +49 881 183-0
Fax: +49 881 183-420
E-Mail: info@wtw.com
Internet: www.wtw.com